



NOVELAN



Scope of delivery, Montage,
Electrical connections,
Installation of sensors, Dismantling



Software update



Switching on / Commissioning



Program area "Cooling"



Program area "Service"



Program area "Parallel mode"

Appendix

OPERATING MANUAL

WPR-NET

HEATING AND HEAT PUMP CONTROL

Part 2



www.novelan.com



Please read first

This operating manual is part 2 of the 2-part operating manual for the heating and heat pump controller. Ensure that you have part 1 of this operating manual. If part 1 is missing, request it from your supplier

This operating manual provides important information on the handling of the unit. It is an integral part of the product and must be stored so that it is accessible in the immediate vicinity of the unit. It must remain available throughout the entire service life of the unit. It must be handed over to subsequent owners or operators of the unit.

Read the operating manual before working on or operating the unit. This applies in particular to the chapter on safety. Always follow all instructions completely and without restrictions.

It is possible that this operating manual may contain instructions that seem incomprehensible or unclear. In case of questions or uncertainty, contact the factory customer service department or the manufacturer's local service partner.

This operating manual is intended only for persons assigned to work on or operate the unit. Treat all constituent parts confidentially. The information contained herein is protected by copyright. No part of this information may be reproduced, transmitted, copied, stored in electronic data systems or translated into another language, either wholly or in part, without the express written permission of the manufacturer

Symbols



Information for users.



Information or instructions for qualified technicians and authorised service personnel.



DANGER

Indicates a direct impending danger resulting in severe injuries or death.



DANGER

Indicates danger to life due to electric current!



WARNING

Indicates a possibly dangerous situation that could result in severe injuries or death.



CAUTION

Indicates a possibly dangerous situation that could result in medium or light injuries.



IMPORTANT

Indicates a possibly dangerous situation, which could result in property damage.



NOTE

Emphasized information.



ENERGY SAVING TIP

Indicates suggestions that help to save energy, raw materials and costs.



Users and qualified technicians can set data.
Access: User.



Authorized fitter can set data; password required.
Access: Installer.



Authorised service personnel can set data. Access via USB stick only.
Access: After sales service.



Factory pre-setting, no data change possible

1., 2., 3., ... Numbered step within a multi-step instruction for action. Adhere to the given sequence.

- List.
- ✓ Prerequisite for an action.
- Reference to further information elsewhere in the operating manual or in another document.



Contents

PLEASE READ FIRST.....	2
SYMBOLS.....	2



SCOPE OF DELIVERY, MONTAGE, ELECTRICAL CONNECTIONS, INSTALLATION OF SENSORS, DISMANTLING	
SCOPE OF DELIVERY	5
Installed control scope of supply.....	5
Wall control scope of supply	5
MONTAGE.....	5
Assembly of the installed control.....	5
Assembly of the wall control.....	5
ELECTRICAL CONNECTIONS.....	6
Motherboard.....	6
Installation of the Wall control.....	7
Control unit variants	8
Assembly and Installation of sensors.....	9
External sensor.....	9
Hot water sensor.....	9
External return flow sensor.....	10
DISMANTLING	10
Removal of the buffer battery.....	10
SOFTWAREUPDATE / -DOWNGRADE.....	10
SWITCHING ON / COMMISSIONING.....	11
STARTUP GUIDE	12
Fix startup parameters.....	13
Reset startup parameters.....	13



PROGRAM AREA "COOLING"

SELECT PROGRAM AREA	14
SETTING THE MODE OF OPERATION "COOLING"	15
SET TEMPERATURES.....	15
SET PARAMETERS	16



PROGRAM AREA "SERVICE"

SEKECT PROGRAM AREA	17
QUERY INFORMATION.....	17
Query temperatures.....	17
Query inputs.....	18
Query outputs	18
Query elapsed times.....	19
Query operating hours.....	19
Query error memory.....	19
Query switch offs.....	19
Query the system status	20
Query heat quantity.....	20
Query energy input.....	20
Query building services management system (BMS).....	21
Query Smart.....	21
MAKING SETTINGS.....	22
Determine data access.....	22
Calling up preset program	22
Determining temperatures	22
Determining priorities	24
Determining system setting.....	25
Ventilating the system	29
Fix startup parameters	29
Enter serial number	30
Save error memory externally.....	30
RBE – room control unit.....	30
Pump flow.....	30
Smart.....	31
Smart Grid.....	31
Operating states.....	31
Set decrease / increase	32
Terminal diagram Smart Grid.....	32
SELECTING LANGUAGE OF THE SCREEN DISPLAY.....	32
DETERMINING DATE AND TIME	32
SCREED HEATING PROGRAM.....	33
Setting temperatures and time intervals.....	33
Starting screed heating program	33
Manually terminating screed heating program.....	34
HEATPUMP CONFIGURATION.....	35
STARTUP GUIDE	35
RESET STARTUP PARAMETERS	35
DATA LOGGER	35
CONTROL PANEL.....	35
Adjusting the contrast of the control unit display.....	35
Web server.....	35
Remote maintenance	35
Switch on the remote maintenance function	36
Adjust the remote maintenance function.....	36
Check connection.....	36
Manual data transfer.....	36
Error causes with connection problems.....	37
Information on the remote maintenance function.....	37



PROGRAM AREA "PARALLEL CONNECTION"

BASIC INFORMATION	38
Broken connection.....	38
ADDITIONAL HEAT GENERATOR.....	40
Heating mode.....	40
Preparing domestic hot water	40
MIXING CURCUITS.....	40
HEAT QUANTITY AND ENERGY INPUT	40
SELECT PROGRAM AREA	40
IP-ADRESS	41
Set the network addresses.....	41
EXTERNAL RETURN FLOW SENSOR	41
SETTING ON THE MASTER HEAT PUMP	42
Network.....	42
Search for Slaves.....	42
Status of the master	42
SETTING THE HEATING	43
APPENDIX	
ERROR DIAGNOSIS / ERROR MESSAGES	44
Acknowledging a fault.....	48
Flashing codes on controller board.....	48
TECHNICAL DATA	49
Installation.....	49
Outputs	49
Inputs.....	49
Connections.....	49
Interfaces.....	49
Protection class.....	49
Temperature sensor characteristic curve.....	49
Sensor measuring range.....	50
OVERVIEW: DEFROST CYCLE, AIR DEFROST, FLOW MAX	51
SYSTEM SETTING DURING COMMISSIONING.....	52
ABBREVIATIONS (SELECTION)	55



Scope of delivery

NOTE

Function-critical temperature sensors (return, inlet, hot gas) are installed in the heat pump and are not part of the scope of supply of the heating and heat pump regulator.

The heating and heat pump regulator is supplied in two variants. The variant supplied is dependent on the device type of the heat pump to the controlled.

INSTALLED CONTROL SCOPE OF SUPPLY

In the case of devices for internal mounting, the motherboard of the heating and heat pump regulator is integrated in the relevant device as an "installed control". The "installed control" scope of supply is included in the scope of supply of the device for internal mounting.

- Heating and heat pump regulator, consisting of motherboard (with terminals) and control unit (with status display, screen and "rotary pushbutton")
- External sensor for the surface mounting
- Operating manual (in two parts)
- Brief description of the heat pump control.

NOTE

Please fasten brief description in the vicinity of the device.

WALL CONTROL SCOPE OF SUPPLY

In the case of devices for external mounting, the motherboard of the heating and heat pump control is not integrated in the relevant device but in the wall control.

- Heating and heat pump control for surface mounting, consisting of motherboard (with terminals), housing and control unit (with status display, screen and "rotary pushbutton")
- Wall mounting materials (drill template, screws, dowels for solid masonry)
- External sensor for the surface mounting
- Operating manual (in two parts)
- Brief description of the heat pump control

NOTE

Please fasten brief description in the vicinity of the device.

1. Check the supplied product for signs of external damage during delivery.
2. Check that nothing is missing from the scope of supply. Immediately submit a complaint in the event of delivery defects.

Montage

ASSEMBLY OF THE INSTALLED CONTROL

In the case of devices for internal mounting, the motherboard of the heating and heat pump is integrated in the electrical switch cabinet of the device.

- Operating manual of your heat pump, assembly of the control unit

ASSEMBLY OF THE WALL CONTROL

For all work to be carried out:



NOTE

Observe the locally-applicable accident prevention regulations, statutory provisions, ordinances and directives.



WARNING

Only qualified technicians may mount the heating and heat pump control.

1. Position the drill template at the point where the heating and heat pump control is to be located.



IMPORTANT

Check the potential mounting location for concealed wiring. Position the drill template in such way that no concealed wiring can be drilled into or damaged during the subsequent assembly work.



NOTE

You need to ensure ≥ 2 cm free space to the right and left of the drill template, so that there is enough space for the side fastening screws of the housing cover.

2. Fix drill template onto the wall with adhesive tape, drill holes ($\varnothing 6$ mm, depth ≥ 55 mm).

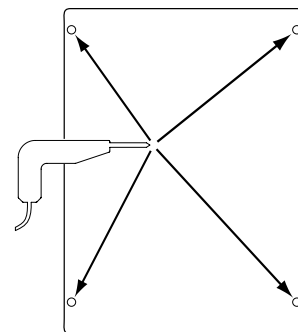

3. Take drill template off the wall, insert dowels in the holes, screw in screws (spacing from the substrate to the screw head approximately 10mm).



NOTE

The wall mounting material included in the scope of supply requires solid masonry.



! IMPORTANT

Ensure that the screws are firmly in the substrate.

- Loosen right and left fastening screw of the housing cover for the heating and heat pump controller.

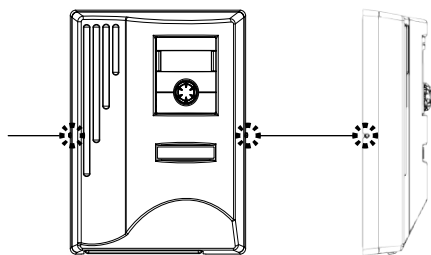

- Remove housing cover and set aside in a safe place.
- Hang the heating and heat pump control into the screws on the wall. Tighten the screws.

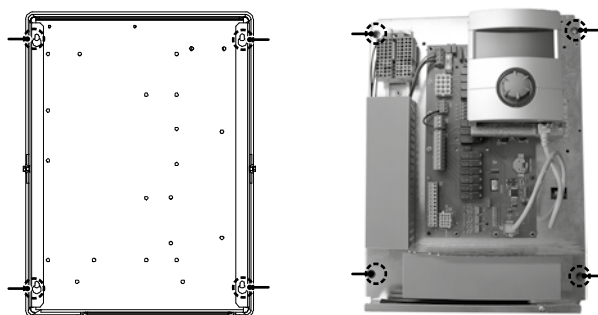

①

1 Rear view

②

2 Front view

- If the electrical installation is not to be carried out immediately afterwards: Put the housing cover back on and tighten the side fastening screws.

Electrical connections



DANGER

Danger of fatal injury due to electric current!

Electrical connections may be installed only by qualified electricians.

Before opening the unit, disconnect the system from the power supply and secure it from being switched back on!



WARNING

During installation and while carrying out electrical work, comply with the relevant EN-, VDE and/or local safety regulations.

Comply with technical connection requirements of the responsible power supply company (if required by the latter)!

Follow the information in the operating manual of your heat pump for establishing the electrical connections.

→ Operating manual of your device, "Electrical Connections", "Terminal Diagram" for your device type

MOTHERBOARD

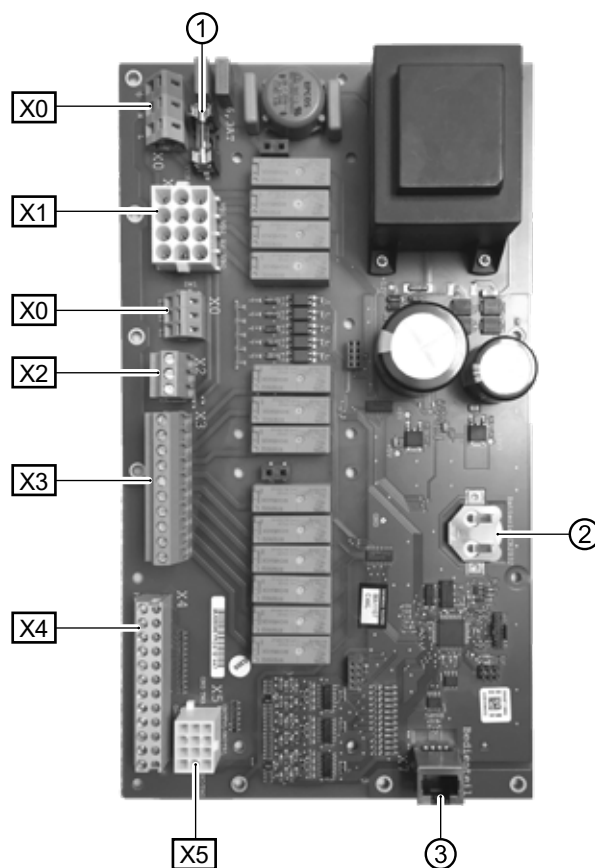

1 Fine fuse (6,3 AT)

2 Buffer battery

3 RJ45 socket for patch cable to control unit

X0 Terminal block (at the top): Control voltage

X0 Terminal block (centred): 230 V distribution (continuous current)

X1 Terminal block: Connection for 230 V control line to the heat pump

X2 Terminal block: 230 V inputs

X3 Terminal block: 230 V outputs

X4 Terminal block: External sensor inputs

X5 Terminal block: Internal sensor inputs



INSTALLATION OF THE WALL CONTROL

1. If not yet carried out: Remove housing cover of the heating and heat pump control.

→ section "Montage", "Assembly of the wall control", instructions 4. – 5.

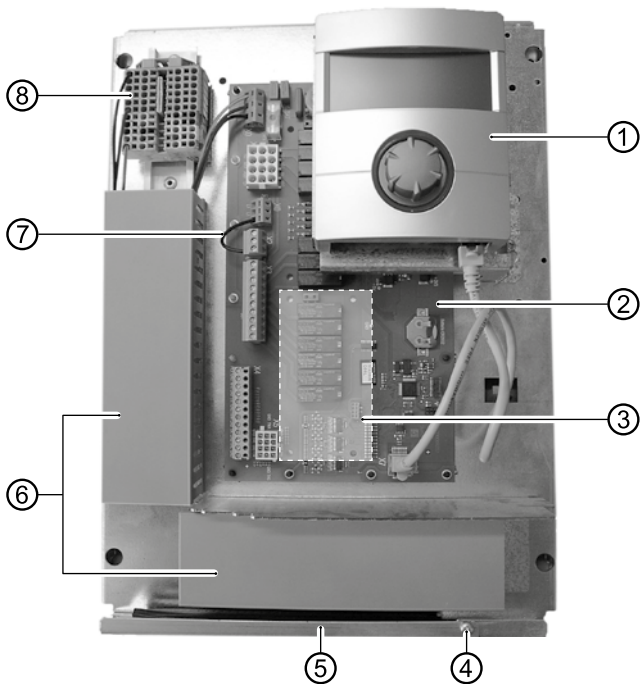

- 1 Control unit
- 2 Motherboard of the heating and heat pump control
- 3 Slot for optional „Comfort board 2.0“
- 4 Fastening screw of the folding bracket
- 5 Cable entry with folding bracket
- 6 Cable ducts with covers
- 7 Electricity supply utility bridge (must be removed when connecting a floating contact)
- 8 Terminal block for 230 V voltage supply

2. Loosen fastening screw of the folding bracket for the cable entry and pull the folding bracket downwards until it is possible to fold away upwards. Fold folding bracket upwards and away to the side .

3. Remove covers from the cable ducts.

4. Insert plug of the 230 V control line leading to the heat pump into socket X1. Then route the control line downwards through the cable ducts and outwards through the cable entry.

5. Insert plug of the sensor line into socket X5. Route the sensor line downwards through the cable ducts and outwards through the cable entry.

6. Connect the 230 V voltage supply line to the voltage supply terminal block.



NOTE

The terminal block has spring-type terminals to maximum 2.5 mm². Insulate the cable jacket so that the jacket end is located between the sealing lip and cable duct.

Basic wiring:

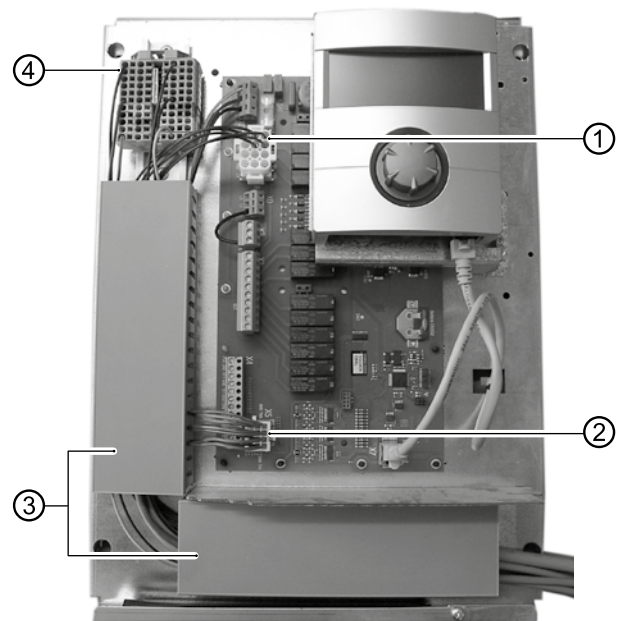

- 1 Connected 230 V control line to the heat pump
- 2 Connected sensor line to the heat pump
- 3 Line wiring in the cable ducts
- 4 Connected 230 V voltage supply

7. If necessary, install additional external cables.

→ Instruction manual for your appliance, "Connection layout" and "Circuit diagrams" for your appliance type



NOTE

The inputs and outputs on the motherboard are assigned as shown on the device's terminal connection diagram. In addition, the assignment is shown on the inside of the housing of the wall-mounted controller.

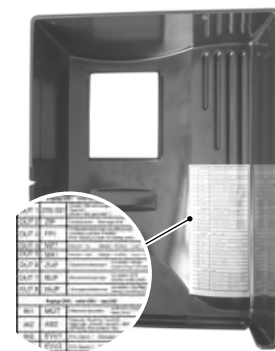

8. Place covers on the cable ducts. Swivel folding bracket of the cable entry back into the initial position and allow to latch into place below the fastening screw. Tighten fastening screw.

9. Put the housing cover back on and tighten the side fastening screws.



IMPORTANT

Route all lines that you connect to the heating and heat pump control outside the heating and heat pump in a cable duct (necessary for strain relief; to be realised at the customer).



- K Cable duct
- 1 1~/N/PE/230V power supply; cable cross-section max. 2.5 mm²
- 2 Further 230 V inputs (electricity supply utility lock, ...)
- 3 Sensor lines (external) including the TRL return sensor on the return to the heat pump
- 4 Further 230 V outputs (circulation pumps, mixers, ...)
- 5 Sensor line from terminal block X5 to the heat pump
- 6 230 V control line from terminal block X1 to the heat pump

→ Installation instructions for this in the operating manual of your heat pump.

CONTROL UNIT VARIANTS

Depending on the heat pump type, the control unit integrated in the heating and heat pump controller is equipped with the following interfaces:

TYPE 1

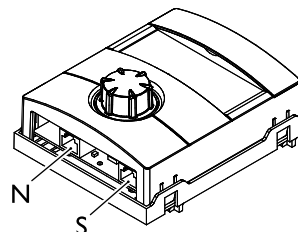

- N Network
- S Connection to the control board

TYPE 2

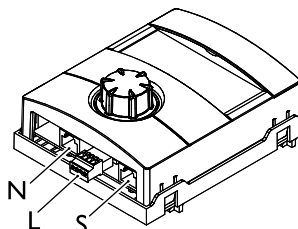

- N Network
- L LIN-BUS
- S Connection to the control board

TYPE 3

Control unit for the use of a room control unit for devices with software version 1...
(accessories subject to a charge)

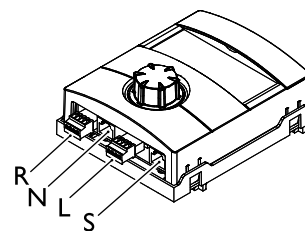

- R RS485 for connecting the room control unit (RBE)
- N Network
- L LIN-BUS to the control board
- S not assigned



NOTE

Check the software status before replacing the control units
(→ page 20, "Query the system status").
If the software version is < 1.85, perform a software update.
Replace the control units **only after the software update** has been completed.



ASSEMBLY AND INSTALLATION OF SENSORS

External sensor

The external sensor (protection class IP 67) is a function-critical accessory and included in the scope of supply.

NOTE

If the external sensor is not installed or defective, the heating and heat pump regulator automatically sets the external temperature to -5 °C. The status display of the control unit lights up red, the screen of the control unit reports an error.

IMPORTANT

Mount the external sensor on the north or northeast side of buildings. The sensor must not be exposed to direct sunlight. The cable gland must point to the base.

1. Open the housing of the external sensor and align ≥ 2 m over the base of the fastening point.

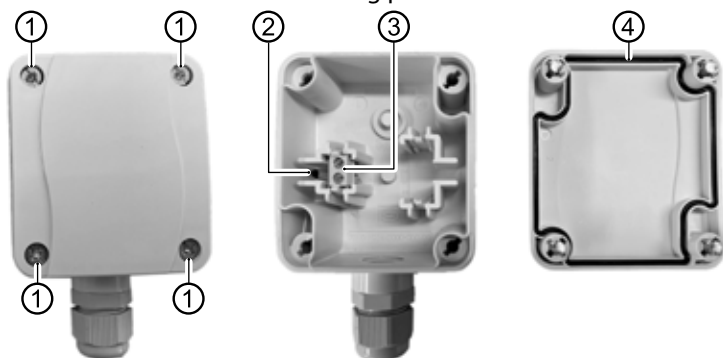

- 1 Quick-release screws
- 2 NTC sensor element 2.2 k Ω at 25 °C
- 3 Cable clamps
- 4 Housing sealing in housing cover

2. Mark the fixing holes on the fixing point and drill them into the fixing point. Insert dowels and screw the housing of the external sensor to the wall.

NOTE

Dowels and screws for fastening the external sensor are not included in the scope of supply.

3. Loosen cable gland and lead a 2-wire cable (\varnothing 5 - 9,5 mm, cross section ≤ 1.5 mm² per wire, cable length ≤ 50 m) through the cable gland into the housing.
4. Fit the cable wires with wire end sleeves, place them on the cable clamps of the external sensor and tighten them with a torque of 0.5 Nm.
5. Tighten cable glands with a torque of 2.5 Nm and close the housing of the external sensor. Ensure that the housing seal and the sealing surfaces are clean and that the housing seal is in the correct position.

IMPORTANT

No moisture may be trapped in the housing. If necessary, completely dry the inside of the housing before mounting the housing cover.

Ensure that the tightness of the housing is guaranteed by mounting it tension-free and that no water can penetrate the housing of the external sensor at any time (for instance during the construction phase).

Dimensional drawings

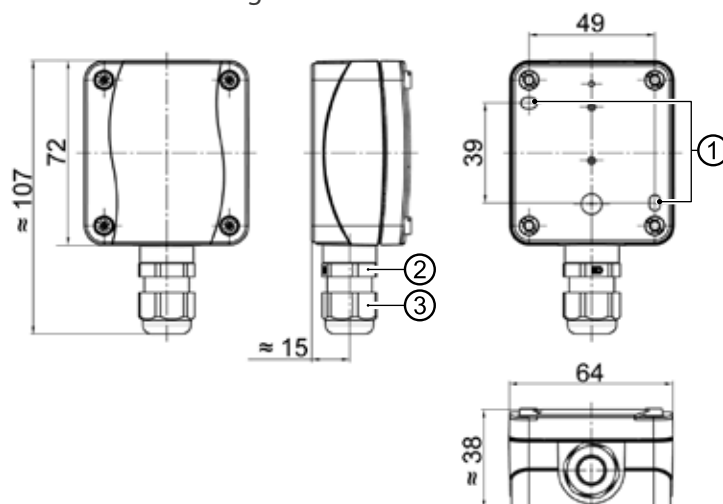

All dimensions in mm.

- 1 Fastening holes (\varnothing 4,3)
- 2 Cable gland M16 x 1,5
- 3 Cable gland SW 20

Hot water sensor

The domestic hot water sensor is an optional accessory and only functionally-relevant for a separate domestic hot water tank. You may only use domestic hot water sensors which have been approved by the manufacturer of the heat pump.

IMPORTANT

The domestic hot water tank must be filled before connecting the domestic hot water sensor to the heating and heat pump regulator.

If not already prepared at the factory, mount the domestic hot water sensor ($\varnothing = 6$ mm) on the halfway level of the domestic hot water tank – and always above the internal heat exchanger of the domestic hot water tank.

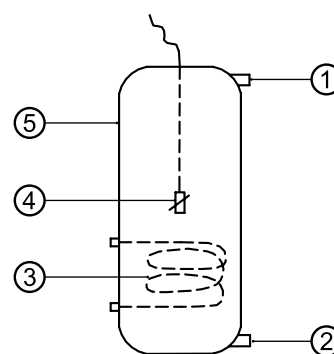

- 1 Domestic hot water connection
- 2 Cold water connection
- 3 Heat exchanger
- 4 Domestic hot water sensor ($\varnothing = 6$ mm)
- 5 Hot-water tank



External return flow sensor

The return flow sensor (optional accessory) is functionally-relevant for hydraulic integration of an isolating tank (multifunction tank.). This has to be installed as follows:

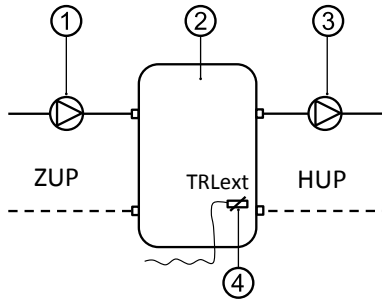

- 1 Separation or multi-functional storage tank
 - 2 Circulation pump in the separation storage tank (heat pump circuit)
 - 3 Circulation pump from the separation storage tank (heating circuit)
 - 4 External return sensor ($\varnothing = 6 \text{ mm}$)
- ZUP Charging loop, heat pump
HUP Discharging loop, heating circuit

Connect the return flow sensor coming from the isolating tank to the circuit board of the heating and heat pump regulator.

Dismantling



DANGER

Danger of fatal injury due to electric current!
Electrical connections may be installed only by qualified electricians.
Before opening the unit, disconnect the system from the power supply and secure it from being switched back on!

REMOVAL OF THE BUFFER BATTERY

! IMPORTANT

Before scrapping the heating and heat pump regulator, remove the buffer battery on the main board. You can use a screwdriver to remove the battery from its bracket. Dispose of battery and electronic components in keeping with environmental considerations.

Softwareupdate / -downgrade

Software updates/downgrades can be carried out via the USB interface on the control unit of the heating and heat pump controller.

1. Expose the USB interface on the control unit.
→ Part 1 of the controller manual, program area "Service", section "Basic Information on the operation"
2. Insert a USB stick with the software into the USB interface and follow the on-screen instructions.

! IMPORTANT

A software version $< V2.63$ must not be loaded on a unit (only LAD and SIP37.1 – SIP69.1 and SIP29.1H – SIP56.1H) with software version $\geq V2.63$.



Switching on / commissioning

If the system is ready for operation but not yet configured (initial switching on), then the language selection is displayed first.

→ Select the display language: part 1 of the controller manual, section "Basis information on the operation".

NOTE

The language must be confirmed.

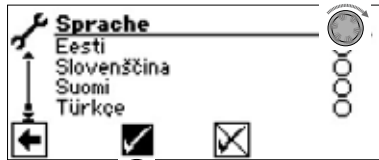

Then click on the navigation arrow in the language display. The following display then appears:

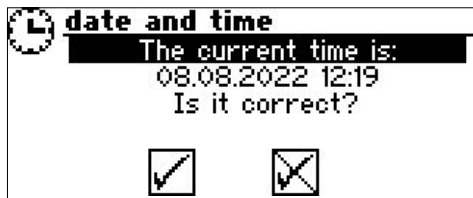

The question always appears when the controller voltage is switched on, provided it has been interrupted for > 20 hours.

If the date and time are correct, select and click . Otherwise, select and click , set the correct date and time and save. Then select and click on the navigation arrow in the display.

After that a security question appears:

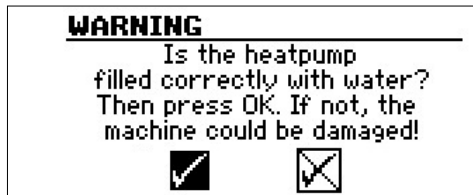

The security question always appears when the controller voltage is switched on or after a restart of the heating and heat pump controller (reset). This screen is no longer displayed if the heat pump or ZWE1 has more than 10 operating hours.

No ZWE (second heat generator) is released by the controller until the display is confirmed with .

NOTE

No heat generator runs during a cold start of air/water heat pumps.

IMPORTANT

The unit can be damaged if the display is confirmed with , although the system is not properly filled.

NOTE

For SIP 37.1 – SIP 69.1 and SIP 29.1H – SIP 56.1H it is necessary to select whether water or brine is to be used as the heat source fluid, otherwise the unit doesn't work.

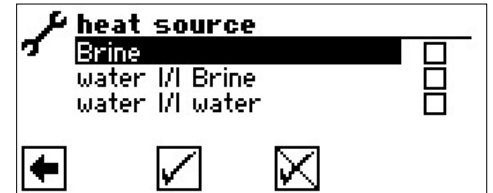

Brine

Must be selected if the heat pump is operated with a brine-water mixture (= standard). Whether probes or surface collectors are used is irrelevant.

If there is an **intermediate heat exchanger** on the heat source side:

Water |/| Brine

Must be selected if water is used as the heat source medium on the primary side of the intermediate heat exchanger and a brine-water mixture is used on its secondary side.

Water |/| Water

Must be selected if water is used as the heat source medium on both the primary and secondary sides of the intermediate heat exchanger. For the water/water setting the heat source inlet temperature must be at least 7°C or higher.

The minimum temperature of the heat source (T-HS min) will be set automatically depending on the selected medium.

→ page 52, "System setting during commissioning", "T-HS min"

NOTE

If no heat source is selected and the enquiry is only answered by navigating to and selecting , "Brine" is automatically set as the heat source.

A subsequent change of the heat source medium as well as "T-HS min" is only possible with customer service access.

For SIP heat pumps, after selecting the heat source, a screen appears on which the SWP heat pump's performance class must be selected so that the calculation of the energy input can be done correctly.

→ page 54, "type of heat pump"

NOTE

The performance class can also be set in the startup guide or later in the "System settings" menu in the "type of heat pump" menu line.



On switching on the controller voltage, this screen is displayed for LAD and SIP 37.1 – SIP 69.1 and SIP 29.1H – SIP 56.1H:



After deleting this display the unit can be operated properly. Otherwise disconnect the heating and heat pump controller from the power supply, check the 3-pole cable for the BUS connection and rectify any faults found.

The following display then appears:



NOTE

The heating phase until the compressor starts can take several hours when starting up air/water heat pumps for the first time.

NOTE

In the case of LAD units the flow is monitored while the pump is running. If the flow is not ok, the heat pump does not start up and no error is displayed. To this end, check the ASD input, if it is not set to ON the flow is too low.

→ page 18, "Query inputs"

After that, the navigation screen appears.

So long as the heat pumps have not yet been configured, the "GO" symbol flashes at the top right of the navigation screen.



Navigating to and clicking on "GO" calls up the startup guide. This assistant will guide you through the most important settings of the regulator during initial commissioning.

After the initial commissioning has been completed, the "GO" symbol will no longer be displayed.

→ page 12, "Startup guide" and page 13, "Reset startup parameters"

If you do not wish to use the startup guide, first make the settings required for your system in the "System settings" menu (→ page 25, "Determining system setting").

Then set the desired temperatures (→ page 22, "Determining temperatures").

Then make all other settings that are necessary for the conditions of your installation.

Startup guide

If the startup guide is not called up via the flashing "GO" symbol in the navigation screen, this can be done in the "Service" program area.

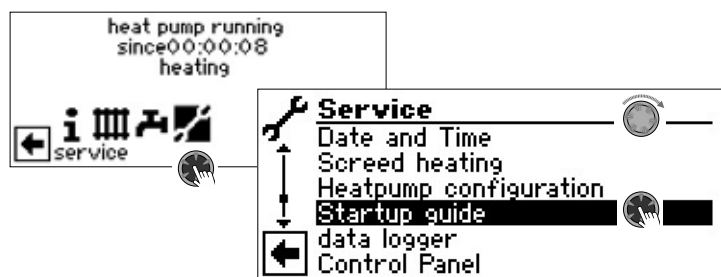

You will be guided step-by-step through several selection options used to set up your heat pump.

For example:

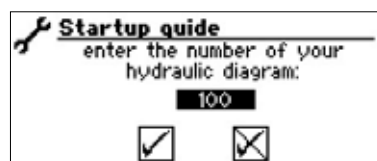

For the number of the control setting, please refer to the hydraulic diagrams we have published.

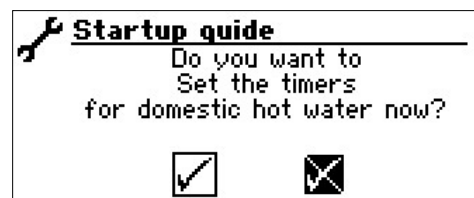

Further queries will follow.



For more information on the commissioning assistant, please refer to the corresponding sections in this operating manual.

NOTE

As soon as the startup guide has been executed once, the menu item "Reset Startup Parameters" appears on the display instead of the "Startup guide" menu item.



FIX STARTUP PARAMETERS

With installer or customer service access, it is possible to save the settings made during commissioning (= startup guide). This allows you to quickly and easily reset the system to the status it had at startup.

The data is stored on the circuit board of the control unit.

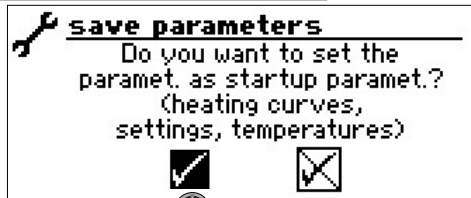
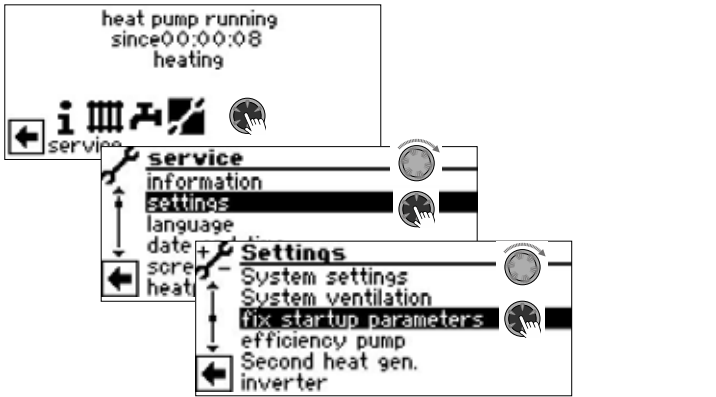

Follow the instructions on the screen and save the settings.

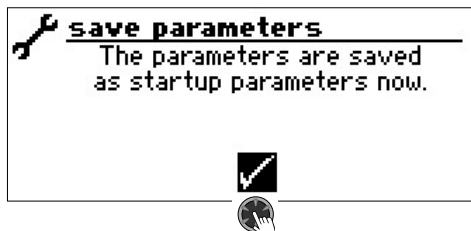

You can also save the settings to an external USB stick.



RESET STARTUP PARAMETERS

If your heat pump was commissioned by an authorised customer service partner and the startup parameters have been stored, you can use this menu item to restore these parameters.

This may be helpful if settings have been changed and led to a system malfunction. Please Notice that all settings such as heating curves, system settings, set values will be reset to the values applicable at commissioning.

The programmed switching times are not affected by this.

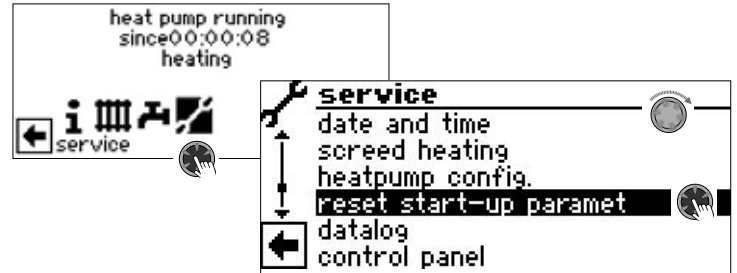

You will be guided through the following menu items:

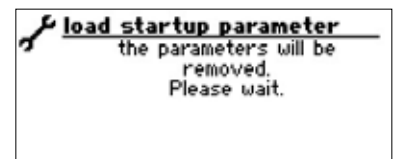
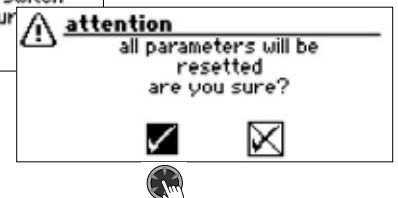



❄️ Program area “Cooling”

! IMPORTANT

Only select the program area “Cooling” if a cooling circle mixer is connected in conjunction with a brine/water heat pump or a LAD.

! IMPORTANT

If a cooling circle mixer is connected, it is imperative to select the program area “Cooling”, as otherwise malfunctions will occur in the mixer connected.

! IMPORTANT

The use of cooling requires that you integrate a dew point sensor in the system. This must then either be connected in series with the cooling sensor or used instead of the bridge, if cooling is provided via the flow cooler.

The program area “Cooling” must be set by authorised service personnel during commissioning.

Necessary setting for brine/water-Heatpumps:

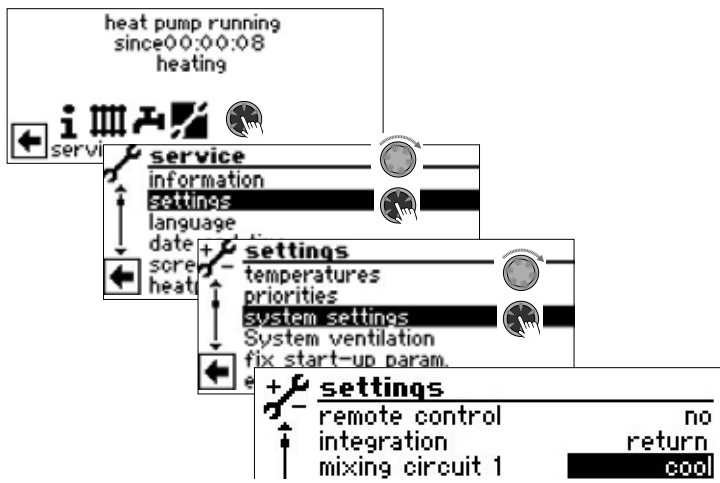

Mixing circ 1 = Cool

Necessary setting for reversible LAD-Heatpumps:

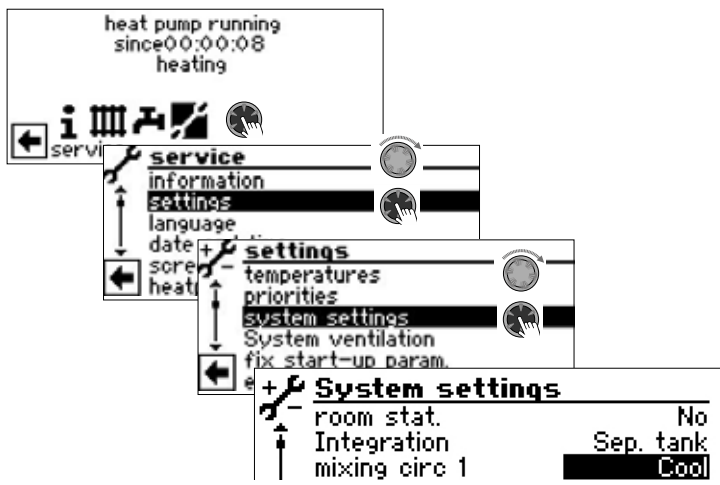

Integration = Sep. tank

Mixing circle 1 = cool

→ page 25, “Determining system setting” “Mixing circ 1”

i NOTE

The minimum flow temperature of cooling is factory set to 18 °C. This value can be changed in the menu “Determining temperatures” in the menu item “min. flow cooling”

! IMPORTANT

For brine/water heat pumps with integrated hydraulic components, do not set the minimum flow temperature of cooling to < 18 °C.

→ page 22, “Determining temperatures”

If the passive cooling function is set, the symbol for the program area ❄️ will appear in the navigation screen:



SELECT PROGRAM AREA

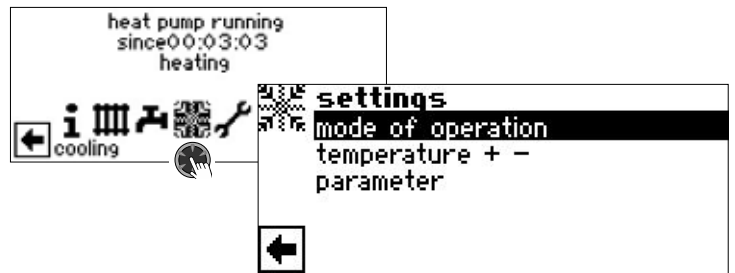

Menu field “mode of operation” leads to the menu “Cooling mode of operation”

Menu field “Temperatur + -” leads to the menu “Cooling Temperature”

Menu field “Parameter” leads to the menu “Cooling Parameter”

SETTING THE MODE OF OPERATION "COOLING"

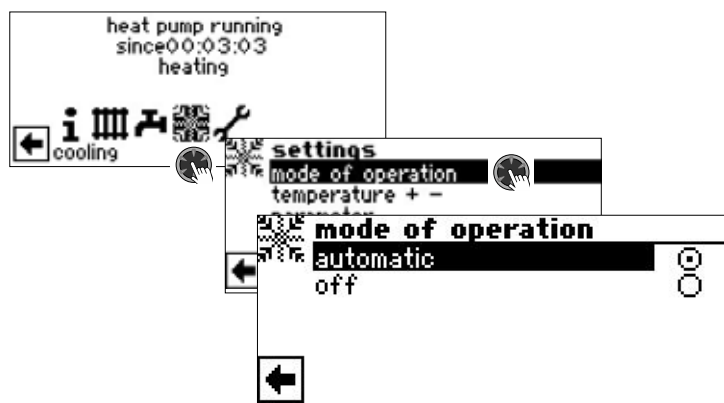

The current mode of operation is highlighted with :

Auto

Switches the cooling function on depending on the outside temperature release or in accordance with a fixed set temperature (= setpoint temperature).

Off

Cooling is generally deactivated.

NOTE

Cooling is always the lowest priority.

Example: If there is a demand for domestic hot water, the cooling will be interrupted or not released.

NOTE

Activate the automatic mode only during the summer months or shut off the cooling during the heating period by means of a room thermostat.

Otherwise, it is possible that, depending on the location of the outdoor sensor, the system will switch to cooling if the outdoor temperature exceeds the set temperature.

NOTE

Automatic operation also means that during the summer months the system will automatically change over to heating mode or to the operating mode selected in the "Heating" program area as soon as the outside temperature drops below the preset value.

In order to ensure that the system does not start to heat during the summer months, the operating mode for the heating can be set to "Off".

→ Part 1 of the controller manual, program area "Heating", section "Setting the operating mode for the heating"

NOTE

Only SW/WW heat pumps: If the passive cooling function has been switched on, the program of the heating and the heat pump regulator will automatically set the heating to the mode of operation "Off".

The reverse applies:

If the heating has been switched on, the program of the heating and heat pump regulator will automatically set the passive cooling function to the mode of operation "Off".

SET TEMPERATURES

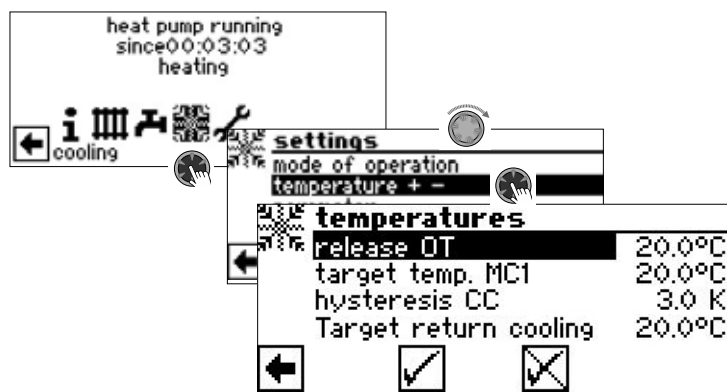

release OT

Required outdoor temperature release

The cooling is enabled for the duration of the time set under "Parameters" when above the preset value.

→ Set parameter

target temp. MC1

Required set temperature for cooling in mixing circle 1

The target value determines the control variable for the activated cooling mixer, insofar as the cooling is to be carried out based on a fixed temperature. If cooling enable is set based on the outside temperature (set. AT.), the menu field "OT diff. MC1" appears here. Then enter a corresponding temperature spread in Kelvin.

hysteresis CC Hysteresis cooling regulator

Without an Comfort board installed, displayed only for reversible LAD heat pumps and controls the automatic changeover from passive to active cooling

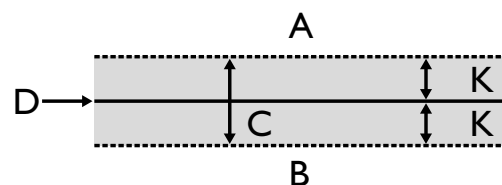

A There will be a request for active cooling in this temperature range

B There will be no request for active cooling in this temperature range

C Neutral zone

D Set temperature of mixing circuit

K Hysteresis in Kelvin

target return cooling

Menu field "Target return cooling" is shown only with reversible LAD-heatpumps.



SET PARAMETERS

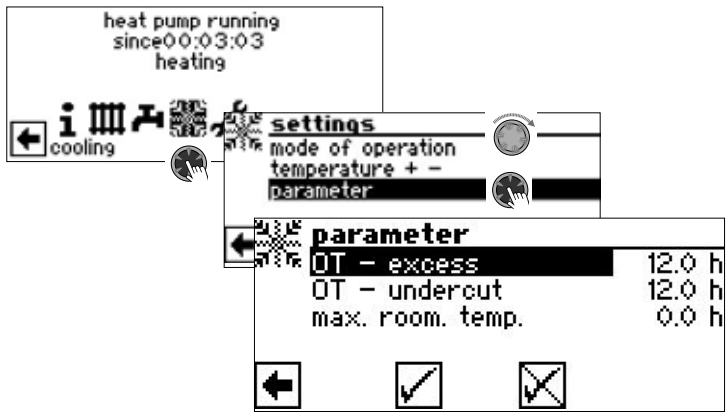

OT – excess (maximum outside temperature)

Cooling starts in the “Automatic” operating mode if the outdoor temperature is exceeded for longer than the time set under “OT – excess” or once by more than 5 K.

OT – undercut (minimum outside temperature)

Cooling is terminated in the “Automatic” operating mode if the outdoor temperature falls below the set time for “OT – undercut” for longer than the outdoor temperature

max. room. temp. (maximum room temperature)

The menu field for regulating the cooling based on room temperature depending on the outside temperature appears only if the system has a room control unit (RBE) and the corresponding settings have been implemented

→ Operating manual RBE – Room control unit

NOTE

For brine/water- and water/water-heat pumps the cooling will only be enabled if the brine inlet temperature is $> 2\text{ }^{\circ}\text{C}$. The set setpoint temperature defines the flow temperature of the heat pump during cooling.



Program area "Service"

NOTE

The software automatically detects the connected heat pump type. Parameters that are not relevant for the conditions of the system and/or the heat pump type are hidden. Some of the parameters documented in this program area may therefore not appear on the screen of your heating and heat pump controller. Many menus require scrolling with the "rotary pushbutton".

NOTE

Some menu entries and parameters are also only visible or adjustable when installation technician or customer service access is active. The different data access levels are marked in this operating manual by symbols.

→ page 2, "Symbols"

NOTE

Some parameters have adjustable value ranges. These can be found in the appendix.

→ page 52, "System setting during commissioning"

SEKCT PROGRAM AREA

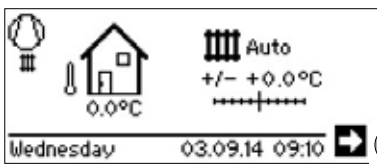

QUERY INFORMATION

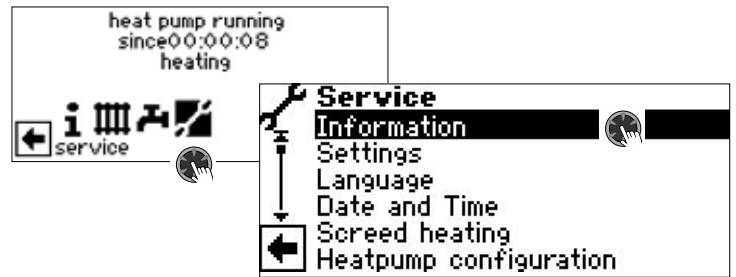

Query temperatures

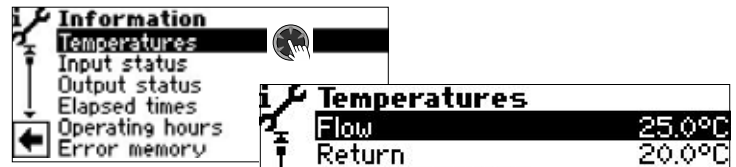

The menu is not shown in full here.

Flow	Flow temperature heating circle
Target flow	Flow setpoint temperature heating circle
Return	Return flow temp. of heating circle
Ret. targ.	Return setpoint heating circle
Return external	Return temp. in separate tank.
Hot gas	Hot gas temperature
amb. temp.	External temperature
Average temperature	Average temperature outside over 24 h (function heating limit)
Act. service water	Domestic hot water actual temperature
Targ. service water	Domestic hot water target temperature
Heat source in	Heat source inlet temperature
Heat source out	Heat source outlet temperature
MC 1 flow	Mixing circle 1
MC 1 target flow	Forward flow temperature
flow max.	Mixing circle 1
room stat.	Forward flow set temperature
	maximum flow temperature
	Current temperature of the room
	remote adjuster (RFV) or room control unit (RBE)

In addition – depending on the unit type of the connected heat pump – the cooling circuit information provided by sensors in the cooling circuit appears here.



Query inputs



The menu is not shown in full here.

NOTE

This menu shows whether the digital inputs of the controller are switched on or off.

Defr/Brin/Flow	Defrost, Brine pressure, flow
Depending on the device type, the input can fulfil various functions:	
	For L/W-devices
	Defrost end pressostat:
	On = Defrost is terminated.
	For LAD, LAP, S/W and W/W devices with flow switch connected at the factory:
	On = Flow okay.
	For S/W-devices without flow switch connected at the factory, a brine pressostat can be connected:
	On = brine pressure sufficient.
SW-therm. switch	Domestic hot water thermostat
	On = Domestic hot water requirement
Energy supply company	Off-time of the electrical supplier
	Off = Off-time
High pressure	High-pressure pressostat
	Off = Pressure okay
Motor protect.	Motor protection
	On = Motor protection okay.
Low pressure	Low pressure pressostat
	On = Pressure okay.
potent. ext.	Connection of an external current anode (possible for some devices)
Analog In ...	Analogue input signal (e.g. for flow sensor)
release cooling	ON = cooling enabled (from external) present
High pressure	High-pressure sensor
Low pressure	Low-pressure sensor
flow	Heating circuit flow rate
Smart Grid	1 EVU blocking time
	2 decreased operating mode
	3 normal operating mode
	4 increased operating mode
	→ page 31, "Operating states"
El. Sup. bl. 2	Additional energy supplier (EVU) signal for displaying the Smart Grid states
STB E-Rod	Safety temperature limiter (STB) for monitoring the electric heating element
	ON = STB OK
	OFF = STB has triggered

Query outputs

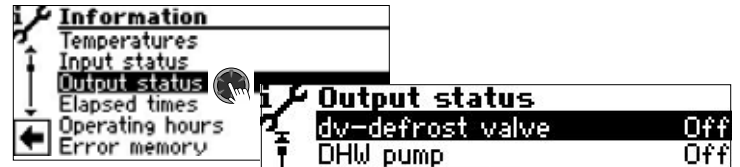

The menu is not shown in full here.

dv-defrost valve	Valve / Circuit reversal
	ON = Thaw mode or rather cycle reversal becomes active
DHW pump	Domestic hot water circulation pump
Floor heat. pump 1	Floor heating circulation pump
heat. sys. pump	Heating circulation pump
mixer 1 Open	Mixer 1 opens
	On = opens / Off = no control
mixer 1 Close	Mixer 1 Close
	On = closes / Off = no control
Ventilation	Ventilation of the heat pump housing for certain L/W devices.
Fan-heats. pump	Ventilator, well or brine circulation pump
Compressor	Compressor(s) in heat pump
Compressor 1	Compressor 1 in heat pump
Compressor 2	Compressor 2 in heat pump
CP	Circulation pump
suppl. pump	Additional circulating pump
2nd heat gen. 1	Second heat generator 1
2nd heat gen. 2	Second heat generator 2 – Collective fault (function collective fault: Continuous ON in the event of a fault, cycles 1x per second with automatic RESET enabled)
AO ...	Analogue output ... (power supply e.g. for flow sensor)
Control signal UWP	Circulation pump output in %



Query elapsed times



The menu is not shown in full here.

Heatpump since	Heat pump running since (Time indication respectively in hh:mm:ss)
ZWE1 since	Second heat generator 1 running since
ZWE2 since	Second heat generator 2 running since
Switch on delay	Net input delay
Swi c time	Off-time switching cycle
read-CPd	Compressor Read-CPd
HC Add-time	Heating control more time
HC Less-time	Heating time less time
ThDsin.sin	Thermal disinfection running since
block ser.wat.	Off-time domestic hot water
release ZWE	Release of second heat generators
Defrosting	Time until the next defrosting
lock 2nd cp. hg	Disabling of 2nd compressor in the event of hot gas exceedance

Query operating hours



The menu is not shown in full here.

Op. h. comp1	Operation hours compressor 1
Impulses comp. 1	Impulses compressor 1
Duration comp. 1	average duration compressor 1
Op. h. comp2	Operation hours compressor 2
Impulses comp. 2	Impulses compressor 2
Duration comp. 2	average duration compressor 2
Operation hours ZWE1	Operation hours second heat generator 1
Operation hours ZWE2	Operation hours second heat generator 2
Operation hours hp	Operation hours Heat pump
Operation hours heat	Operation hours Heating
Operation hours hw	Operation hours domestic hot water
Operation hours cool	Operation hours Cooling

NOTE
The compressors are only energised alternately following the impulses. A variation in the operation hours of the compressors is, therefore, possible.

Query error memory

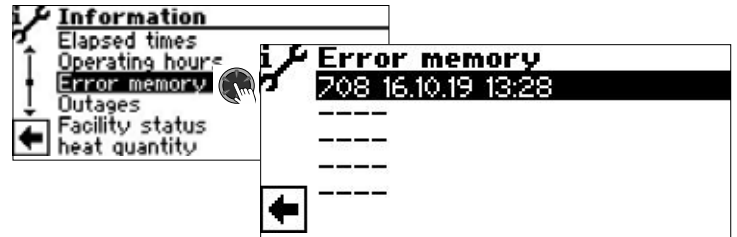

728
Error number (here by way of example)
16.10.19
Date of the resulting error (here by way of example)
13:28
Time of the error that occurred

If an entry is clicked, the corresponding information for this entry is displayed.

→ Meaning of the error numbers: page 44

NOTE
Maximum the last five resulting errors are displayed.

Query switch offs

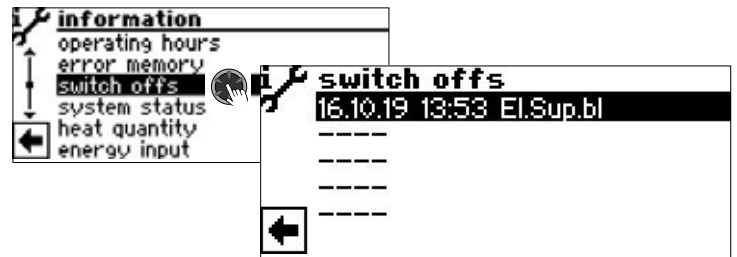

16.10.19
Date of the disconnection (here by way of example)
13:53
Time of the disconnection (here by way of example)
El. Sup. bl
Disconnection code (here by way of example)

Error hp	heat pump fault
err.inst.	system fault
m.o. ZWE	mode of operation second heat generator
El. Sup. bl	el. sup. blockade
Defr. air.	air defrost
TPLmax	temperature limits maximum of application
TPLmin	temperature limits minimum of application
low lim	lower limit of application
no requ.	no request
TEE	External energy source
flow	Flow
p0_break	Low pressure pause
u0_break	Superheating pause
I0 break	Inverter pause
D0 break	Desuperheater pause
OpMode	Operating mode for switching over
Stop	Other shutdown

NOTE
Maximum the last five disconnections are displayed.



Query the system status

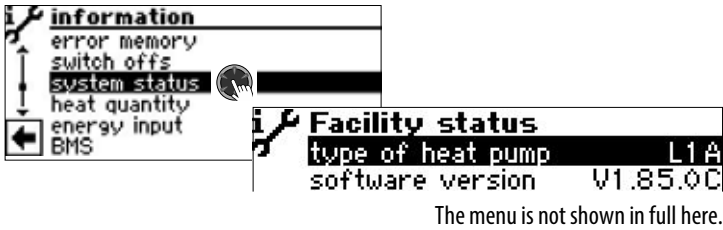

The menu is not shown in full here.

Type of heat pump	Type of heat pump
Software version	Software version of the heating and heat pump regulator
Revision	Processor version
Bivalent level	Bivalent level: 1 = one compressor may operate 2 = two compressors may operate 3 = additional heat generator may operate as well
Operation mode	Current operation mode: Heating, DHW, ... Defrost, El.Sup.bl., ...
Software version RBE	Software version of the room control unit (RBE)
Defrost demand	Defrosting requirement in %
Last defrost	Time of last defrost

Query heat quantity

LAD-heat pumps are equipped with heat quantity recording by pressure sensors in the cooling circuit of the heat pump. In these heat pumps the heat quantity can be read out directly – with all other devices of the LAD series, the heat quantity measurement can be retrofitted (accessories subject to a charge).



Heating	Recorded heat quantity for heating
DHW	Recorded heat quantity for domestic hot water
total	Sum of the heat quantity supplied by the heat pump
el. heater	Recorded heat quantity for the electric heating element. If there are several heating elements: Sum of the heat quantity supplied by the el. heaters
Historie	Save the recorded heat quantities to a USB stick for an external backup. After saving, the counter for recording the recorded heat quantities is set to zero.

NOTE
Depending on the system configuration, values for cooling or for the swimming pool also appear.

NOTE
Active cooling with simultaneous domestic hot water preparation is counted in domestic hot water and cooling.

NOTE
The value for “el. heater” is only calculated correctly if the setting „ZWE capacity” (→ page 26) corresponds to the actual capacity of the respective heating element.

NOTE
The values will only be saved by the regulator every 2 hours so that every time the regulator is started it can account for a difference between the actual generated heat quantities and the displayed values.
Recorded values are stored for the last 10 years. After this period, older values are overwritten. It is therefore recommended to export the history at the latest before this period expires in order to be able to access older values if required.
The history should also be exported before manually changing the date set in the heating and heat pump control.

Query energy input

For heat pump types LAD and SIP it is possible to read out the amount of energy consumed.



Heating	Energy consumed for heating
DHW	Energy consumed for domestic hot water
total	Sum of the energy consumed by the heat pump
el. heater	Energy consumed by the electric heating element If there are several heating elements: Sum of the energy consumed by the el. heaters
Historie	Save consumed energy quantities on USB stick for an external backup. After saving, the counter of the energy quantities is set to zero.

NOTE
Depending on the system configuration, values for cooling or for the swimming pool also appear.

NOTE
The value for “el. heater” is only calculated correctly if the setting „ZWE capacity” (→ page 26) corresponds to the actual capacity of the respective heating element.



NOTE

The values will only be saved by the regulator every 2 hours so that every time the regulator is started it can account for a difference between the energy actually consumed and the displayed values.

Recorded values are stored for the last 10 years. After this period, older values are overwritten. It is therefore recommended to export the history at the latest before this period expires in order to be able to access older values if required.

The history should also be exported before manually changing the date set in the heating and heat pump control.

Query building services management system (BMS)



The menu is not shown in full here.

NOTE

Data is only displayed if the heat pump is integrated into a building management system. This requires a special configuration of the heating and heat pump controller with additional software that is subject to a charge.

→ Operating manual "Connection to a building services management system via BACnet/IP | ModBus/TCP"

Query Smart

NOTE

Menu entry is only displayed if customer service access is activated and if:

- Menu entry "room stat." is set to "Smart"
- "Smart" settings have been made.

→ page 25, "Determining system setting", "room stat."

→ page 31, "Smart"



The menu is not shown in full here.

set temperature HC	Setpoint temperature heating circuit
set temperature MC1	Setpoint temperature mixing circuit 1
Targ. service water	Set point temperature domestic hot water preparation
target value max	Highest requirement setpoint from the Smart system
UFH total HC	Number of floor heating circuits assigned to the heating circuit
UFH open HC	Number of open floor heating circuits assigned to the heating circuit
numb.actuat. HC	Number of radiator drives assigned to the heating circuit
Cur. room temp. HC	Current room temperature of the worst room in the heating circuit
Targ. room temp. HC	Target temperature of the worst room in the heating circuit
UFH total MC1	Number of floor heating circuits assigned to the mixing circuit 1
UFH open MC1	Number of open floor heating circuits assigned to the mixing circuit 1
numb.actuat. MC1	Number of radiator drives assigned to the mixing circuit 1
Cur. room temp. MC1	Current room temperature of the worst room in the mixing circuit 1
Targ. room temp. MC1	Target temperature of the worst room in the mixing circuit 1



MAKING SETTINGS

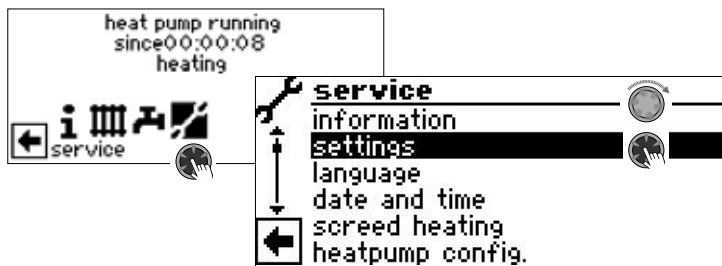

Determine data access

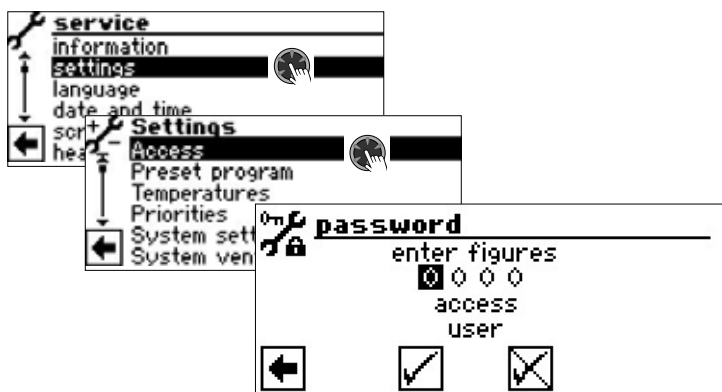

Enter numbers

entry fields of the four digits numerical code:

Activate the first entry field of the numerical code by pressing the "turn-push button".

Set the first digit by turning the "turn-push button" and confirm the entry by pressing the button.

Move to the respective next entry field and repeat the steps described above.

Finally, move to and save the entries by pressing the "turn-push button".

The entry fields are automatically set to 0000. The cursor goes automatically to the navigation arrow. The program provides information in the menu line "Access" on the selected status of the data access.

Data access

Information on the current status of the data access (here: user)

! IMPORTANT

Incorrect program settings that are not aligned to the system components can cause malfunctions or even serious damage to the system. Therefore, access to basic settings of the system via the installer password 9445 may only be carried out by qualified technicians and must be blocked for unauthorised persons.

After service work, it is essential to reset the data access to "User" (enter and save number code 0000).

i NOTE

The manufacturer is not liable for damage resulting from wrong program settings not oriented towards the system components.

If the "rotary pushbutton" has not been used for 3 hours, data access is automatically reset to "User".

Calling up preset program

→ Part 1 of the controller manual, program area "Service", section "Calling up preset program".

Determining temperatures

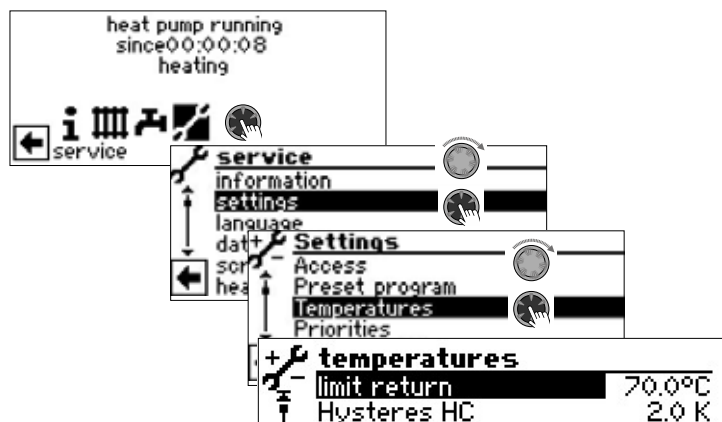

The menu is not shown in full here.

Limit Return

Return limit

Setting the maximum return setpoint temperatures in heating mode.

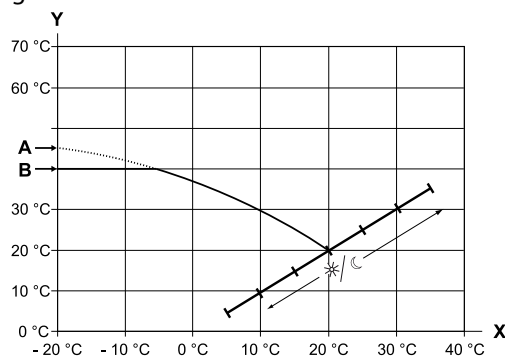

X External temperature

Y Return temperature

A Heating curve-end point

B Return limit (in the example shown: 40 °C)

Hysteresis HR

setting for the control hysteresis of the heating regulator

Set a greater hysteresis for very reactive heating systems, and a lower hysteresis for less reactive heating systems.

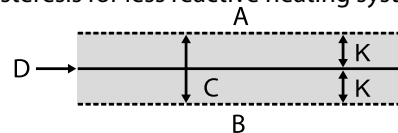

A There will be no request for heating in this temperature range

B There will be a request for heating in this temperature range

C Neutral zone

D Return setpoint temperature

K Hysteresis in Kelvin



hysteres.SW Hysteresis of domestic hot water
Setting for the control hysteresis for the domestic hot water preparation (negative hysteresis).

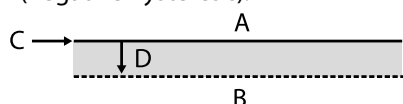

- A There will be no request for domestic hot water preparation in this temperature range
- B There will be a request for domestic hot water preparation in this temperature range
- C Domestic hot water target
- D negative hysteresis

RT incr.max Return increase maximum
Setting for the maximum permissible overshoots of the return temperature. If the return temperature is overshoot, internal minimum running times are ignored and all heat generators switched off. Always set value higher than the value of the hysteresis HR.

Release 2 CP Release 2nd compresso
A value is only displayed for devices with two compressors. Setting of the minimum external temperature from which the second compressor can be released in heating mode. Above the set external temperature, the second compressor remains locked in heating mode

Release ZWE Release second heat generator
Setting for the external temperature from which the second heat generator can be released if required. Above the set external temperature, the second heat generators remain locked.
Exception:
In the event of a fault and the setting fault with a ZWE, the second heat generators are released independently of the set external temperature.

Tp-defr.Air. Temperature air defrost
Setting for the release temperature for the air defrost. Below the set temperature, the air defrosting is locked.

! IMPORTANT

Set air defrost only if device type is approved for air defrost.

TVth.disinf2 TDI setpoint temperature
Setting for the setpoint temperature for the thermal disinfection in the domestic hot water preparation.

Flow 2. CP SW Flow 2nd compressor
Domestic hot water
Setting for the flow temperature up to which domestic hot water is prepared with the second compressor. Optimisation of the charging time and the attainable domestic hot water temperatures.

T-outd. max maximum external temperature
Setting for the maximum external temperature from which the heat pump is locked.
Second heat generators are released as required.

T-outd. min minimum external temperature
Setting for the minimum external temperature under which the heat pump is locked.
Second heat generators are released as required.

T-HS min Minimum heat source temperature
Setting for the minimum permissible temperature at the heat source outflow of the heat pump .

for S/W devices:
With AS access, a value above -9 °C can be set (necessary for integration with intermediate exchangers)

for W/W devices
The setting is only available with manufacturer access.

T-HG max Maximum hot gas temperature
Setting for the maximum permissible temperature in the cooling circle of the heat pump.

T-def.airend Temperature air defrost end
A value is only displayed for L/W devices and if the air defrost is switched on.
Setting for the temperature at which the air defrosting is terminated at the outlet of the evaporator.

→ page 51, "Overview: Defrost cycle, Air defrost, Flow Max"

lowering to Maximum lowering
Setting for the external temperature up to which a night lowering is carried out.
If the actual external temperature falls below the set value, the lowering temperature is ignored.

flow max. Maximum flow temperature
If this temperature is exceeded in the flow, a compressor of the heat pump is switched off. This applies to all supply types!

→ page 51, "Overview: Defrost cycle, Air defrost, Flow Max"

Flow max. MC1 Maximum flow temperature mixing circuit 1

min. AT flow max. Heat source temperature-dependent adjustment of the flow temperature.

The outside temperature, up to which the flow max. temperature with the heat pump may be increased, is adjusted here.
Below this outside temperature, the actual VL maximum temperature of the heat pump will fall linearly to the value "low limit of applic."



low limit of applic. Heat source temperature-dependent adjustment of the flow temperature.

Here, the maximum forward flow temperature of the heat pump is set at an outside temperature of -20°C. For further details, see point "min. AT flow max." and the following diagrams:

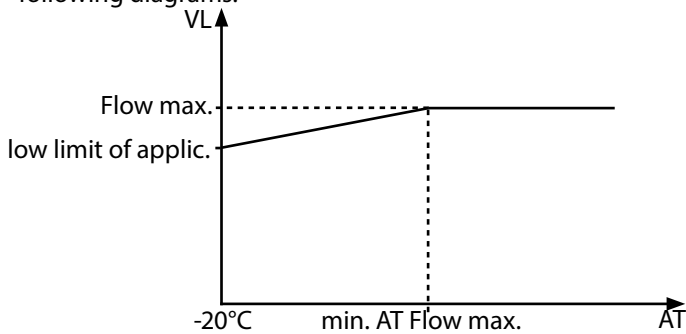

hysteresis cool.contr Hysteresis cooling circuit
Standard value for reversible air/water heat pumps: 3 K
Standard value for brine/water heat pumps: 2 K

service water max Maximum domestic hot water temperature
A value, which is set to limit the maximum set temperature of the domestic hot water.

min.systemtemp. Minimum return set-point temperature
Will not be exceeded in operation.

Defrost end temperature

minimal flow mc 1 Minimum flow temperature mixing circuit 1
Will not be exceeded in operation.

maximum flow mc 1 Maximum flow temperature after the mixer mc 1
Will only be displayed if mixing circuit 1 is set to "Discharge". Then the supply sensor on TB1 serves to restrict the supply temperature in accordance with the mixer. This means that if TB1 exceeds the value set here, the mixer is driven in the "closed" direction.

Hysteresis 2.CP short Hysteresis heating control 2nd compr.
Shorten HR hysteresis. HR. Hysteresis heating regulator from which the cut-in time of the 2nd. compressor stage is shortened (See "System setting").
Cutting-in compressor 2:

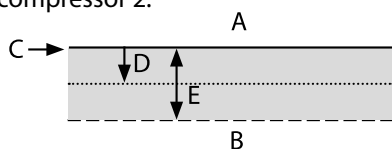

- A No cut-in
- B Shortened cut-in
- C Return flow set value
- D Heat regulator hysteresis
- E Hysteresis HR shortened

min. flow cooling Minimum flow temperature cooling
If the temperature at the cooling sensor falls below this temperature (depending on integration TB1, TB2 or TRL), the cooling is interrupted (factory setting 18°C). At the same time, the displayed value is the minimum limit value for settable cooling setpoint temperatures.

min. flow cooling 2CP Minimum flow temperature cooling 2nd compressor
If the temperature at the cooling sensor falls below this temperature (depending on integration TB1, TB2 or TRL), the cooling is interrupted (factory setting 18°C). At the same time, the displayed value is the minimum limit value for settable cooling setpoint temperatures.

night lowering HC Temperature by which the heating is lowered in night mode compared to day mode.

night lowering MC1 Temperature by which the mixing circuit 1 is lowered in night mode compared to day mode.

Scroll all the way down, save the settings.



Determining priorities

→ Part 1 of the controller manual, program area "Service", section "Determining priorities".



Determining system setting

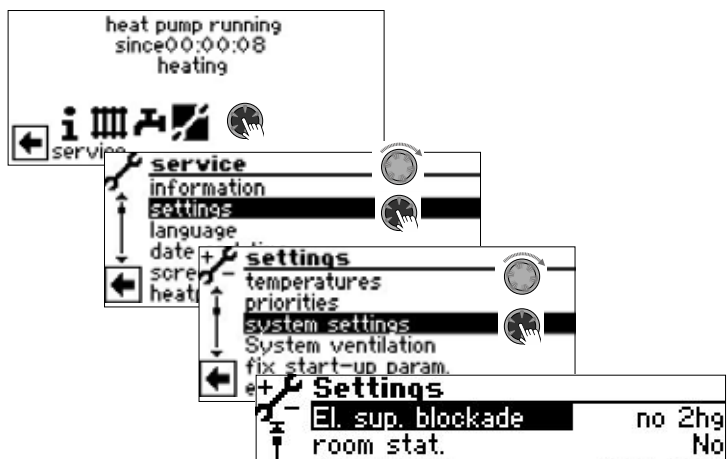

The menu is not shown in full here.

! IMPORTANT

Incorrect settings not oriented towards the system components put the safety and functional capability of the system at risk and can lead to damage.

i NOTE

Enter deviations from the relevant factory settings in the overview "System setting during commissioning".

→ page 52, "System setting during commissioning"

El. sup. blockade	Electrical supply off-times <i>no ZWE</i> <i>with ZWE</i>	ZWE at electrical supply off-time also locked ZWE released for electrical supply Setting only takes effect as ZWE for boiler or thermal.
Roomstat.	<i>No</i> <i>RFV</i> <i>RBE</i> <i>Smart</i>	Roomstation No roomstation connected Room remote adjuster connected RBE room control unit (purchasable accessories) connected Smart-individual room control (purchasable accessories) connected
Integration	<i>Return</i> <i>Sep. tank</i>	Hydraulic Integration hydraulic integration with row tank (flow/return) hydraulic integration with parallel tank (multifunction tank)

i NOTE

External return flow sensor (TRLext) required for "Sep. tank" setting.

Mixing circ 1

Setting the functioning of the mixer control
Charge

Mixing circle 1
Mixer serves as charger mixer, possibly for a boiler

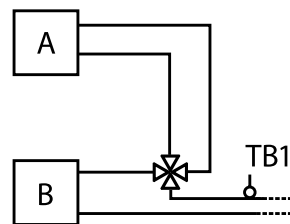

A Boiler
B Heat pump
TB1 sensor flow

Discharge

Mixer serves as a control mixer, possibly for floor heating

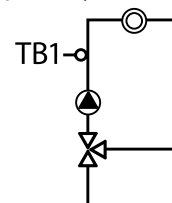

TB1 sensor flow (mandatory)

Cool

Activation of the cooling function (passive for S/W and W/W, active for reversible L/W)

heat+cool

If a mixer is present, it then serves as a control mixer for the cooling function
Activates cooling function (passive for S/W and W/W, active for reversible L/W)
With parallel connection: setting only possible with the master heat pump
If a mixer is available, it then serves as a control mixer for heating and cooling function

No

Mixer without function

i NOTE

For reversible LAD MK1 can also be set to "heat+cool" or "Cool" without the Comfort board by using the fitter or customer service access.

Cooling is controlled via TB1 sensor (via TVL sensor with bridged TB1 contact) for integration of "Return" or via TRLext sensor for integration of "Sep.tank".

ZWE1 type

Type of the second heat generator 1 (ZWE 1)

No

No ZWE connected, system works monovalently

El.Rod

ZWE 1 is an electric heating rod with bivalent level control for heating element (*not released during the El. sup. blockade*), system works mono-energetically

Boiler

Boiler connected as ZWE, system works bivalently The "boiler" setting only requires one charger mixer as the boiler is switched on continuously if required and the temperature is not controlled by the ZWE 1 output.



Thermal

Thermal (gas boiler) connected as ZWE, is activated as heating rod, but can be released during electrical supply off-time

ZWE1 function

No

Heating

HW a. DHW

Function of the second heat generator 1 monovalently

No ZWE connected, system works mono-energetically

ZWE located as a heating rod in the buffer tank

ZWE is located hydraulically in the flow of the heat pump. ZWE is flown through if the heating or domestic hot water circulation pump is running

! IMPORTANT

If integrated circulating heaters are installed in the flow of the heat pump, "HW a. DHW" must be set as a function.

i NOTE

For each ZWE, type and function must be set.

ZWE1 capacity

Only if ZWE1 = El.Rod

The heat quantity and the energy input for a connected electric heating element are calculated based on the value set here. If more than one heating element is connected to the ZWE 1 terminal, the total sum of their capacity must then be set.

ZWE2 type

No

El.Rod

Type of the second heat generator 2 (ZWE 2)

No ZWE 2 connected, the outlet has the function "collective fault"

ZWE 2 is an electric heating rod with bivalent level control for heating element (*not released during the El. sup. blockade*), system works mono-energetically

ZWE2 function

No

Heating

DHW

Function of the second heat generator 2

No ZWE 2 connected, the outlet has the function "collective fault"

ZWE 2 is located as a heating rod in the buffer tank

ZWE 2 is located in the domestic hot water tank

! IMPORTANT

If the ZWE 2 is at "No", the output has the function "collective fault". No ZWE may be connected to this output. Output cycles for self-resetting fault. "Continuous On" at fault.

! IMPORTANT

Only the following ZWE 1 / ZWE 2 combinations are permissible:

ZWE1 function	ZWE2 function	Release
Heating	Heating	✓
Ht a. DHW	Heating	✓
Heating	SW.	✓
No	SW.	✓
No	Heating	X
Ht a. DHW	SW.	✓

ZWE2 capacity

Only if ZWE2 = El.Rod

The heat quantity and the energy input for a connected electric heating element are calculated based on the value set here. If more than one heating element is connected to the ZWE2 terminal, the total sum of their capacity must then be set.

Error

no ZWE

Error

in the event of a fault in the heat pump, connected ZWE are only energised if the return temperature < 15 °C (antifreeze); (only heating)

Heating

DHW

with ZWE

Domestic hot water

in the event of a fault in the heat pump, connected ZWE are energised according to requirements (HW + DHW)

Service water 1

Sensor

Domestic Hot Water 1

Domestic hot water preparation is initiated or terminated via a sensor with hysteresis (factory setting: 2K) in the domestic hot water tank.

Thermal

Domestic hot water preparation is initiated or terminated via a thermostat on the domestic hot water tank.

No temperatures can be set in the controller

i NOTE

Connect domestic hot water thermostat on the same terminals as the domestic hot water sensor (low voltage). The domestic hot water thermostat must be suitable for low voltage (floating contact).

Thermostat closed (= signal On) = Domestic hot water requirement.

Service water 2

CP

Domestic Hot Water 2

Setting CP means circulation pump.

→ For the corresponding settings, please refer to the description of the circulation pump in the operating manual part 1, program section "Domestic hot water", section "Circulation".

h.wCP

Setting h.w.CP means that the CP output will be active during domestic hot water preparation and switch off 30 seconds after domestic hot water preparation is complete.



Service water 3 Domestic Hot Water 3
with CP Additional circulation pump runs during domestic hot water preparation
wo. CP Additional circulation pump does not run during domestic hot water preparation

Service water 4 Domestic Hot Water 4
set value Heat pump attempts to reach the set setpoint value of the domestic hot water temperature

Service water 5 Domestic Hot Water 5
with HUP Heating circulation pump runs always during domestic hot water preparation
wo HUP Heating circulation pump does not run during domestic hot water preparation
par. HUP Heating circulation pump runs parallel to domestic hot water preparation if a heating demand exists. If the heating limit is exceeded, the heating circulation pump switches off.

Heat pump type	Factory setting
SIC	with HUP
LIC	with HUP
WS	with HUP
WIC	with HUP
LAD	with HUP
other devices	wo HUP

SW+HP max Maximum running time domestic hot water preparation + Heat pump
After the set time has expired, the 2nd heat generator in the domestic hot water preparation energises, but only if this has been released previously in the heating mode!

Defr cycle max Defrost cycle time, maximum time between two defrost processes
You can find the time to be set for the relevant L/W device in the operating manual. If you do not find any data there, the following applies:

→ page 51, "Overview: Defrost cycle, Air defrost, Flow Max"

Defrost. Air Air defrost
No Air defrost not released
Yes Air defrost generally released above the set temperature

→ Approved appliances, see page 51, "Overview: Defrost cycle, Air defrost, Flow Max"

! IMPORTANT
Do not set an "air defrost" on non-approved appliances.

Defr. Air max Maximum duration of air defrost
Option only possible if air defrost enabled

pump opt. Pump optimisation
No Heating circulation pumps always run, unless another supply type is requested (domestic hot water, ...) or the device is switched off

Yes
Setting only effective with an outdoor temperature > 0 °C.
Heating circulation pumps are switched off, if required
The heating circulation pumps will be switched if the heat pump has not been requested for more than 3 hours. The heating circulation pumps will then cycle for 5 minutes every 30 minutes until the heat pump receives another request.
If the external temperature is above the return setpoint temperature, the heating circulation pumps will be switched off permanently. They will be switched on for 1 minute every 150 hours to prevent them from becoming stuck

! IMPORTANT
In the case of multi-function domestic hot water tank integration with solid or solar systems, pump optimisation must be set to "No".

Access Data access authorisation
If "Fitter" is selected, all parameters that can otherwise only be viewed and changed with "AS" access (= customer service with USB stick) can be viewed and changed with the installer password.

brine pres/Flow Brine pressure / flow
No neither brine pressure pressostat nor flow switch connected
Brine pres for S/W devices, a brine pressure pressostat is connected on the Defr/Brin/Flow input
flow for W/W devices, a flow switch is connected on the Defr/Brin/Flow input
pow.suppl. Phase monitoring relay installed in the supply pipe of the compressor is connected on Defr/Brin/Flow input
pow.+ flow Phase monitoring relay and flow switch are connected on the Defr/Brin/Flow input

! IMPORTANT
For certain devices, a flow switch is installed at the factory. In this case, always set Defr/Brin/Flow to "pow. Suppl." or "pow.+ flow".
An incorrect setting will compromise the safety and functional capacity of your device and can result in serious damage.

control CP Compressor monitoring
Off Compressor monitoring switched off
On Compressor monitoring switched on, if the rotating field of the supply line is incorrect, a "Net On" fault will be detected

→ page 44, Error number 729
While the compressor is starting up, compressor monitoring checks the change in temperature in the hot gas. If the temperature of the hot gas does not change while the compressor is running, a malfunction is displayed.



! IMPORTANT

Only switch on compression monitoring for error locating during maintenance work.
In the case of devices with a power supply monitor, the compressor monitoring is switched off in the factory setting.

setting hc	Control of the heating circle
Set AT	flow setpoint temperature of the heating is calculated via a set heating curve
Fixed Tp	flow setpoint temperature can be selected independently of the external temperature specification
setting mc1	Control of mixing circle 1
Set AT	return setpoint temperature of the heating is calculated via a set heating curve
Fixed Tp	return flow setpoint temperature can be selected independently of the external temperature specification
screed heating	Mixer behaviour during the screed heating program
Option only possible for external energy source (wood boiler, solar system with parallel tank, ...)	
w. mixer	If the mixer is defined as a discharge mixer, it controls according to the setpoint temperature in the screed heating program
wo. mixer	If the mixer is defined as a discharge mixer, it always starts up during the screed heating program
El. Anode	Electrical anode
Impressed current anode in the domestic hot water tank	
Yes	Impressed current anode present
No	Impressed current anode not present

! IMPORTANT

In the case of devices with an impressed current anode tank, "Yes" must be set in this menu field in order to ensure the corrosion protection of the tank.
The impressed current anode must be connected according to the operating manual of the relevant heat pump.

Heating limit	Switching on / off of the heating limit
Yes	heating limit enabled
No	heating limit switched off
If the heating limit parameter is set to yes, the heating will automatically be switched off to summer mode and vice versa.	
If the heating limit is enabled, the daily mean temperature will be displayed under Service > Informations > Temperatures. At the same time, the heating menu will contain the menu item heating limit. You can use this menu item to set the temperature from which the heat pump is not supposed to provide any more heat. If the mean temperature exceeds the value set here, the return setpoint temperatures are reduced to a minimum and the heating circulation pumps switched off. If the mean temperature falls below the set heating limit, heating mode is resumed automatically.	

parallel mode	Combination of up to 4 heat pumps
No	heat pump works independently
Master	heat pump is the parallel connection master and takes over the heat control of the system
Slave	heat pump is part of a parallel connection and receives commands from the master HP for heating and domestic hot water preparation
→ page 38, "Program area "Parallel connection""	
remote maintenance	Connection to the manufacturer's remote maintenance server
Yes	Remote maintenance function switched on
No	Remote maintenance function switched off
→ page 35, "Remote maintenance"	
pump optim. Time	
If the pump optimisation is switched on (→ Pump opt. = Yes), the time be defined, according to which the heating circulation pumps are switched off.	
If the heat pump is off during this time because there is no need for heating, the pump will loop - 30 minutes off, 5 minutes on, until there is a further heating requirement.	
flow VBO	→ page 30, "Pump flow"
min defrost cycle	Defrost cycle time, minimum timebetween two defrost processes
Take the time to be set from the instructions for use for the respective L/W appliance.	
time 2.CP short	Shortening second compressor stage
Time before the second compressor stage cuts in. If the difference between the return flow set and actual values is greater than the setting "Hysteresis 2.CP short", then the second compressor stage cuts in after this time.	
	NOTE
A compressor may not switch on in more than three times per hour. If this figure has already been reached, cutting in is postponed.	
TDI Message	Thermal disinfection signal
Yes	see error number 759
→ page 44, Error number 759	
No	fault signal/message does not arrive
release ZWE	Release second heat generator
Time until the second heat generator is switched on	
aux. heat. hot water	Hot water reheating
No	Hot water reheating function deactivated (in the factory)
Yes	Activated, the required hot water value becomes the hot water target value
→ Part 1 of the controller manual, program area, "Domestic Hot Water", section "Hot water reheating"	
aux.serv.water max.	maximum time period for hot water reheating
maximum time period, during which the hot water should be reheated. If this time period is exceeded the hot water reheating is cancelled.	



- smart grid
 - No Smart Grid function switched off
 - Yes Smart Grid function switched on
- page 31, "Smart Grid"
- setting mc 1
 - fast fast control speed
 - medium average control speed
 - slow slow control speed
- type of heat pump SIP performance class
 - If an SIP heat pump is connected, its performance class must be set so that the calculation of the energy input can be made correctly.

→ page 54, "type of heat pump"

Scroll all the way down,
save the settings.



Ventilating the system

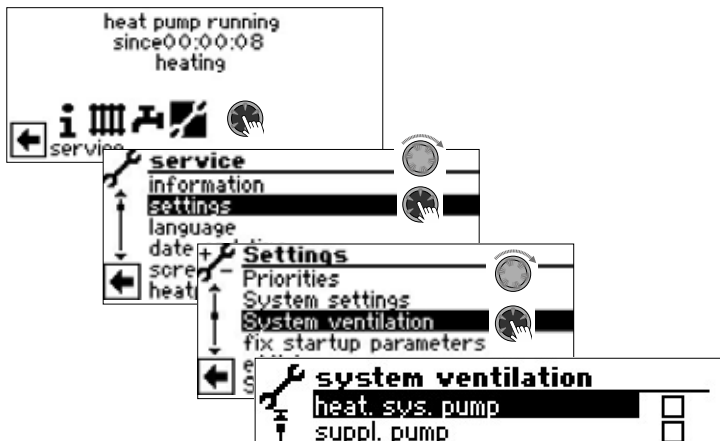

The menu is not shown in full here.

- Heat.sys.pump Heating and floor heating circulating pump
- suppl.pump additional circulating pump
- DHW pump Domestic hot water circulation pump
- fan-heats.pump Fan, well or brine circulation pump
- MC open 1 Mixer 1 OPEN
- MC close 1 Mixer 1 CLOSE
- CP Circulation pump
- fan nozzle heating Fan nozzle heating
- open exp. valve In LAD the expansion valve opens completely for the set running time.
- Duration Running time of the ventilation

1. Activate and select system part(s) to be ventilated.
2. Activate and select menu field "duration", set running time (hour cycle).

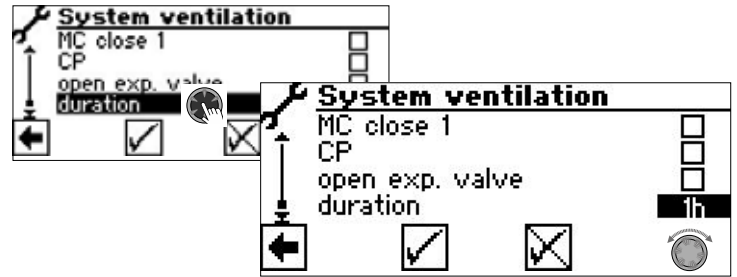

Duration

Factory setting: 1 hour

Value range for running time = 1 – 24 hours.

Save settings.



NOTE

If circulating pumps are selected, the ventilation program will start immediately after the settings have been saved. The ventilation pauses after one hour for 5 minutes and then automatically continues afterwards.

As long as the ventilation program is active, the corresponding program symbol will appear in the navigation screen :



Fix startup parameters

→ page 13, "Fix startup parameters"



Enter serial number

NOTE
Enter the serial numbers of the connected units during commissioning.

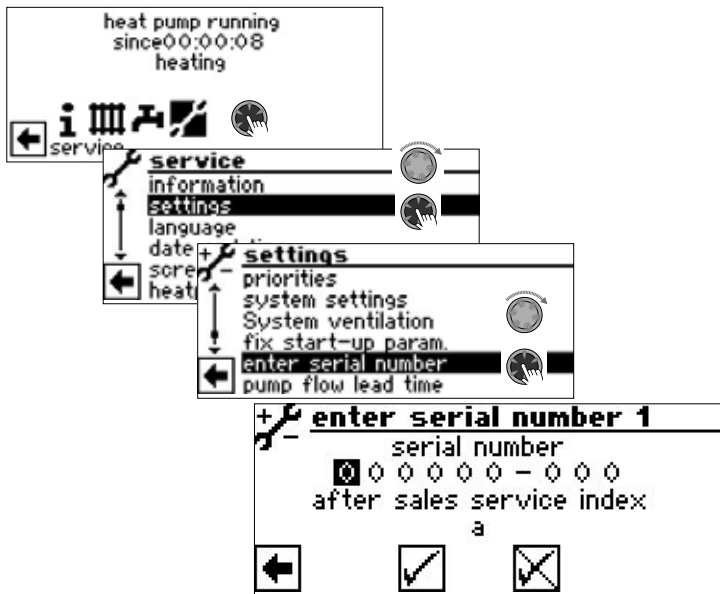

- Serial number 1 Serial number of the heat pump
- Serial number 2 Only if hydraulic unit is not integrated in heat pump:
Serial number of the hydraulic unit
- Serial number 3 only for HID 2: Serial number of the second heat pump

Save error memory externally

NOTE
Use of the function requires customer service access.

The internal error memory of the heating and heat pump controller can be copied to a USB stick. In doing so, a maximum of the last 100 errors that occurred are copied.

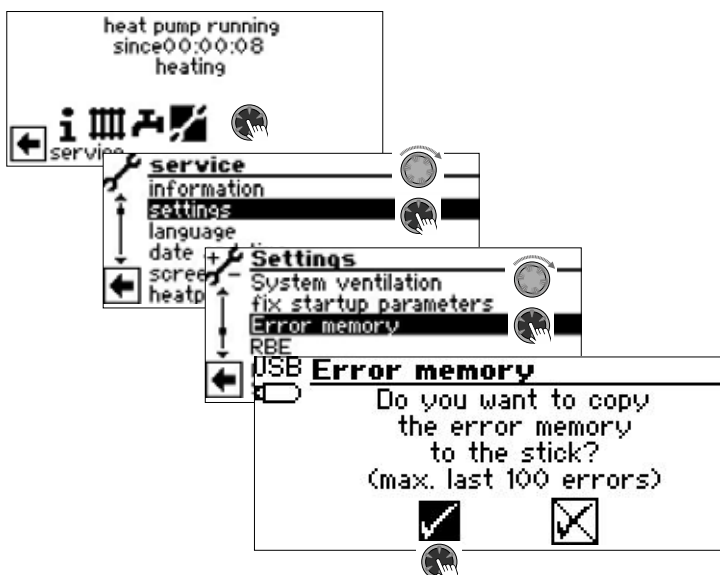

RBE – room control unit

If the system has a RBE room control unit (extra-cost accessory), this is set here:

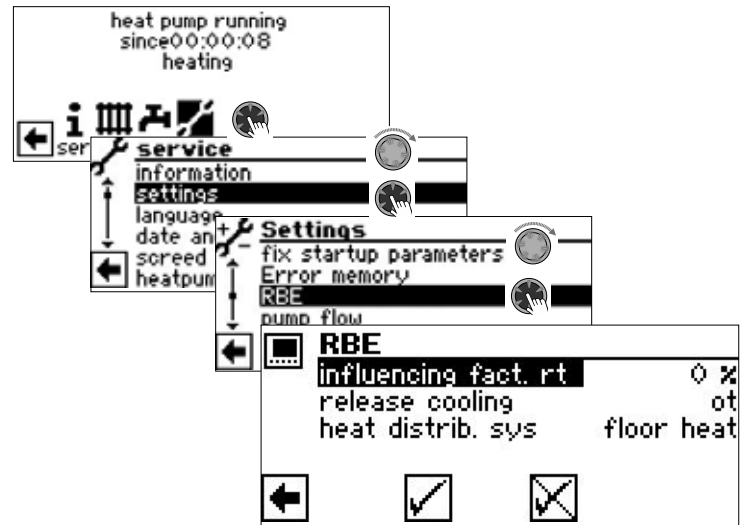

→ Operating manual RBE – room control unit

Pump flow

NOTE
Changing settings requires installer or customer service access.

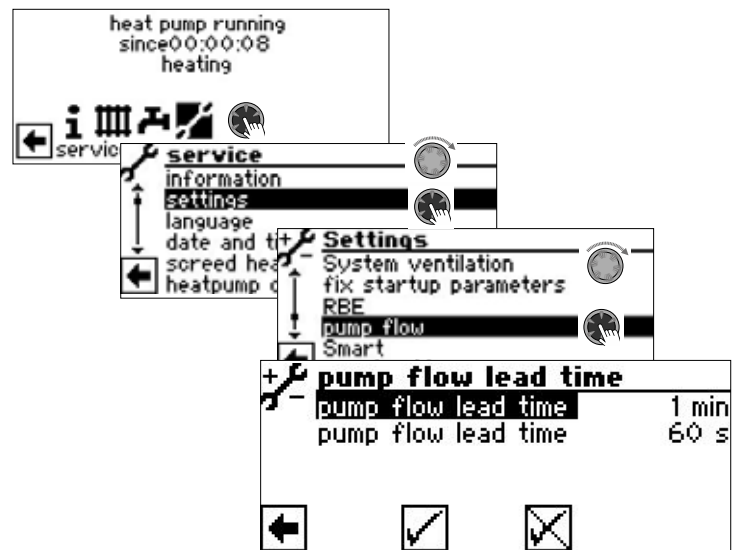

Pump flow lead time VBO Pump flow lead time brine circulation pump VBO
Feed-time for the heat-source pump in brine/water or water/water appliances can be set here. This may be necessary if the time from switching on the pump until the nominal rate of flow is reached is > 30 seconds. The setting is mirrored in the menu "System settings" in the line "flow VBO" and can also be made there.

Pump flow lead time ZUP Pump flow additional circulation pump ZUP



Smart

The "Smart" menu item only appears if individual room controller (extra-cost accessory) is connected to the heating- and heat pump control and the "Smart" option is set under "room stat." (→ "Service > Settings > System settings").

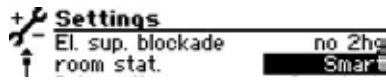

If these requirements are met, settings must be made in the "Smart" menu in order to operate the heating and heat pump controller conveniently via mobile iOS/Android devices.

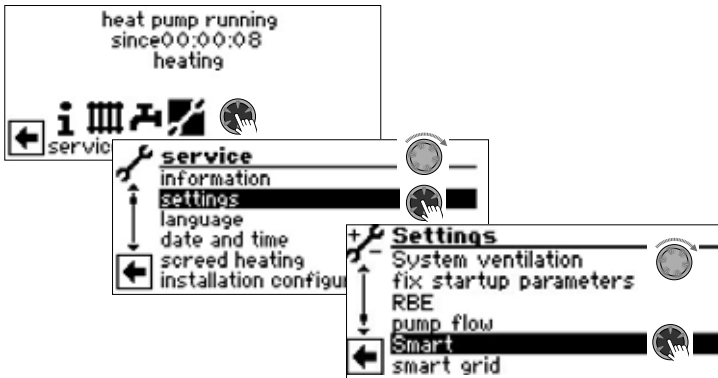

→ Operating manual „Novelan smart“

Smart Grid

Use of the Smart Grid function requires the availability of the Smart Grid functionality in your electricity tariff as well as special wiring.

→ page 32, "Terminal diagram Smart Grid"

NOTE
When the EVU disabling is applied, then the Smart Grid function may not be activated.

NOTE
The menu item only appears if the "Smart Grid" option (→ "Service > Settings") is set to "Yes".

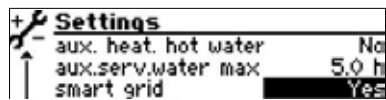

Changing settings requires installer or customer service access.

Operating states

Smart Grid is connected via two contacts of the EVU blocking time, from which four possible operating states result.

EVU 1	EVU 2	Operating status
ON (1)	OFF (0)	1 (= EVU blocking time)
OFF (0)	OFF (0)	2 (= decreased operating mode) The heat pump sets a new setpoint value for the heating, which is lowered by the value "decrease heating". The set HR heating hysteresis applies. Heating: The heat pump operates in the "setpoint value" range minus "decrease heating" +/- HR heating hysteresis in heating mode. NOTE Higher decreases in temperatures can lead to loss of comfort in Smart Grid operation. Domestic hot water preparation: normal preparation.
OFF (0)	ON (1)	3 (= normal operating mode) The target temperature is the set setpoint temperature for heating water and domestic hot water. These set temperatures are held taking into account the respective hysteresis.
ON (1)	ON (1)	4 (= increased operating mode) The heat pump sets a new setpoint value for the heating, which is then increased by the "increase heating" value. The set HR heating hysteresis applies. Heating: The heat pump operates in the "setpoint value" range plus "increase heating" +/- HR heating hysteresis in heating mode. NOTE Higher increases in temperatures can lead to loss of comfort in Smart Grid operation. The return flow limitation temperature must be inspected with integration of a storage tank in series. Domestic hot water preparation: The heat pump sets a new setpoint value for the hot water, which is then increased by the "increase hot water" value. The set hysteresis for hot water applies.



Set decrease / increase

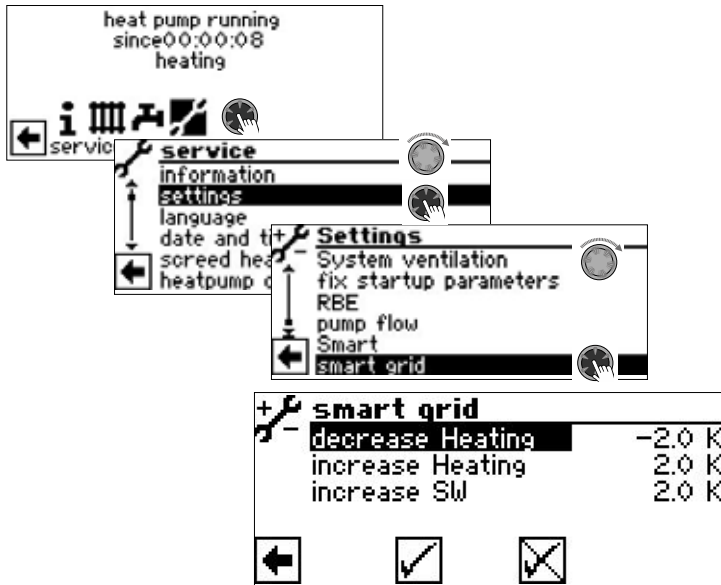

- Decrease Heating Temperature difference in K for heating circuit in operating state 2
- Increase heating Temperature difference in K for heating circuit in operating state 4
- Increase SW Temperature difference in K for domestic hot water heating in operating state 4

NOTE
 Priority controlling is still retained in Smart Grid operation. Return flow limitation temperature (return flow limitation) and flow maximum are also monitored in Smart Grid operation.

Terminal diagram Smart Grid

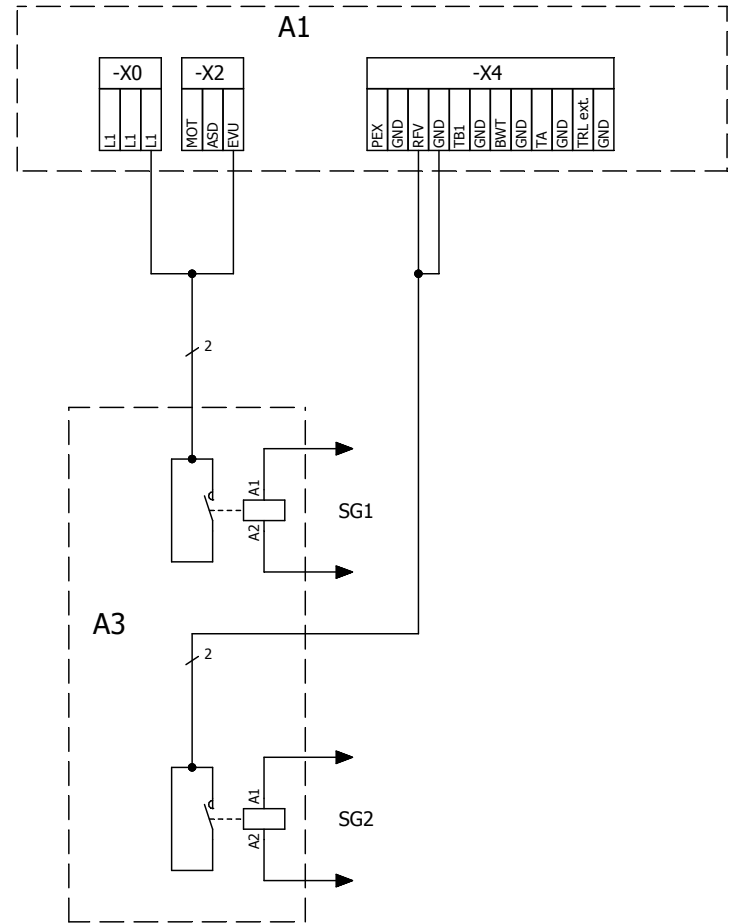

- | | |
|-----------|--|
| Legend: | UK 831209a |
| Equipment | Function |
| A1 | Controller board; Attention: I-max = 6,3A/230VAC |
| A3 | Sub-distribution unit internal installation |
| SG1 | EVU |
| SG2 | RFV |
| | Smart Grid activation 1 |
| | Smart Grid activation 2 |

SELECTING LANGUAGE OF THE SCREEN DISPLAY

→ Part 1 of the controller manual, section "Basic Information on the operation".

DETERMINING DATE AND TIME

→ Part 1 of the controller manual, section "Basic Information on the operation".



SCREED HEATING PROGRAM

The screed heating program is used for automatic heating of screed floors. To do so, the system runs through the ten steps of supply target temperatures in the menu for the respective assigned time intervals. As soon as all stages have been completed, the screed heating program ends automatically.

The outdoor temperature is fixed at -10 °C during the screed heating program in order to avoid various shutdown causes or to guarantee the full functionality of a second heat generator.

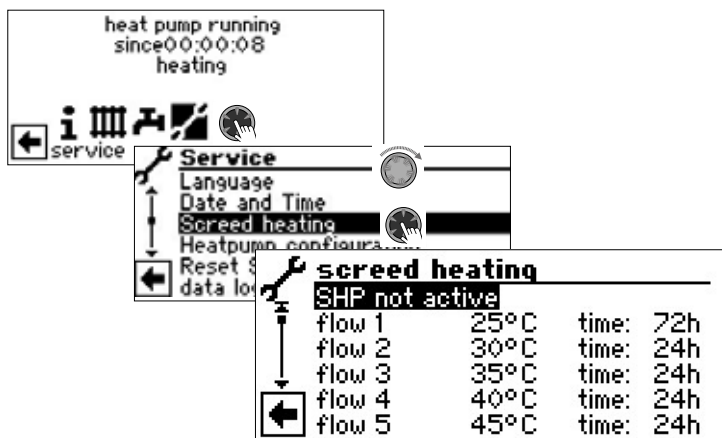

NOTE
Values of the factory setting correspond to the specifications of some screed manufacturers, but can be changed on site.

IMPORTANT
Always check values of the factory setting or desired values in respect to whether they correspond to the manufacturer specifications for the screed which is to be heated.

Setting temperatures and time intervals

Example:

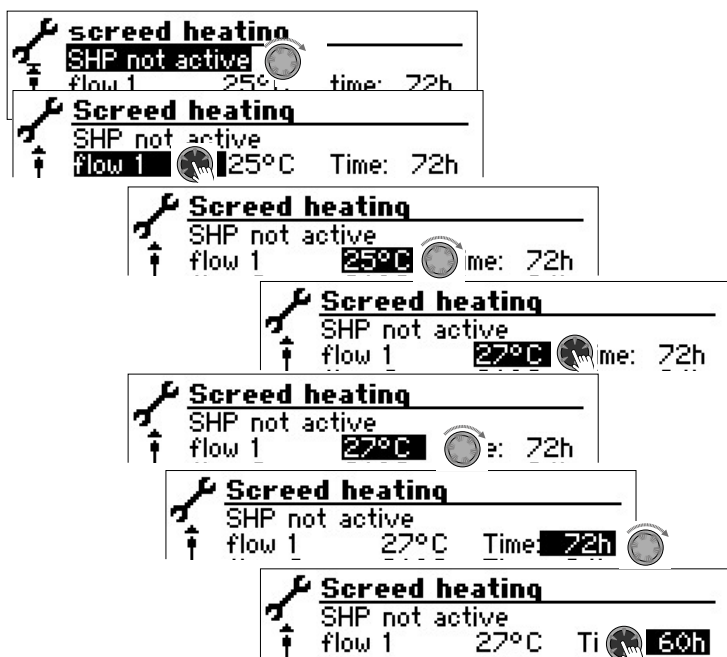

Procedure repeat for the table lines "Flow2" to "Flow10".

NOTE
If less than ten levels are required for heating the screed, set the time interval to "0h" for all levels not required.

IMPORTANT
Do not start any domestic hot water high-speed charge while the screed heating program is running.

NOTE
If the temperatures in the heating system are greater than the setpoint temperature of the first flow temperature level, start the screed heating program with the next highest flow temperature level. Otherwise the screed heating program can trigger an error message in the first flow temperature level.

In order to achieve the desired flow target temperatures, compressors and second heat generators are available depending on the setting in the "Mode of operation Heating" menu:

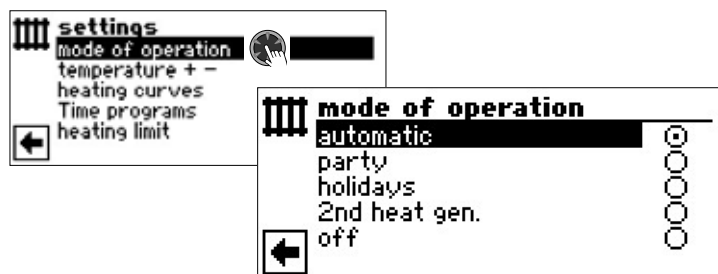

Auto	Compressor switches on on demand ZWE switches on from bivalence stage 3
Second heat gen.	Compressor never switches on ZWE switches on immediately
Off	Compressor switches on on demand ZWE never switches on

Mixing circuits can be integrated into the screed heating program. The controller then attempts to regulate the current temperature setpoint of the screed heating program at the respective flow sensor by opening or closing the mixing circuit valve. The mixing circuit control and temperatures have no influence whatsoever on the sequence of the screed heating program.

To release the function for a mixing circuit, the respective mixing circuit must be set as "Discharge". In addition, the option "w. mixer" must be set under the "Screed heating" system setting.

Starting screed heating program

NOTE
While the screed heating program is running, -10°C is displayed as the outdoor temperature. It is not possible to heat water.

NOTE
In the screed heating program, all connected heat generators are released if necessary. However, the following applies: A heating system is designed for heating in general and not for heating screed. It may therefore be necessary for the screed heating phase to integrate additional heat generators in the system.

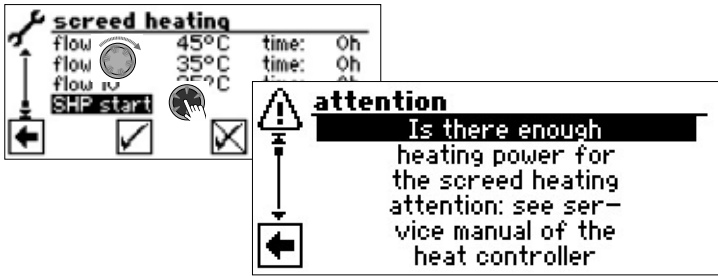

The menu is not shown in full here. scroll down the screen. Answer the confirmation prompt.

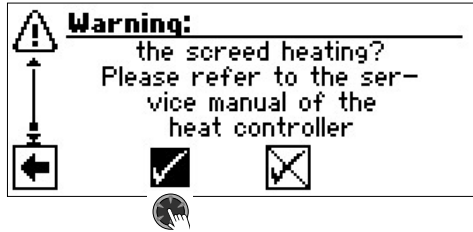

NOTE
 If you respond to the confirmation prompt with , the screen will change back to the menu "Screed heating".

After starting the screed heating program, the programmed flow temperature levels are automatically executed in succession. The time interval set for a flow temperature level is not necessarily the actual time which is necessary to reach the next flow temperature level. Depending on the heating system and power of the heat pump, it may take varying lengths of time until the next flow temperature level is reached.

If a flow temperature level is not reached on account of too low a heating power, a corresponding error message will appear in the screen. The error message informs you about the flow temperature level which has not been reached. However, the screed heating program continues running and attempts to reach the next flow temperature levels.

NOTE
 After expiry of a flow temperature level, the relevant time interval is set to "0h". This ensures that the screed heating program continues after a potential power failure at the start of each flow level at which it was interrupted.

NOTE
 If the error message "Power screed heating" appears (= error number 730), this is only an indication that the screed heating program could not process a flow temperature level in the specified time interval. The screed heating program continues to run nevertheless. The error message can only be acknowledged if the screed heating program has finished or has been manually switched off

As long as the screed heating program is running, the corresponding program symbol will appear in the navigation screen:

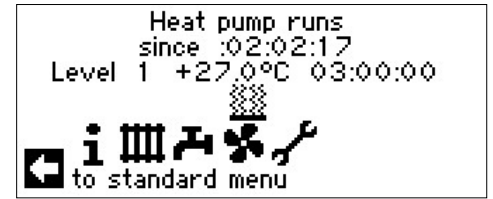

Manually terminating screed heating program

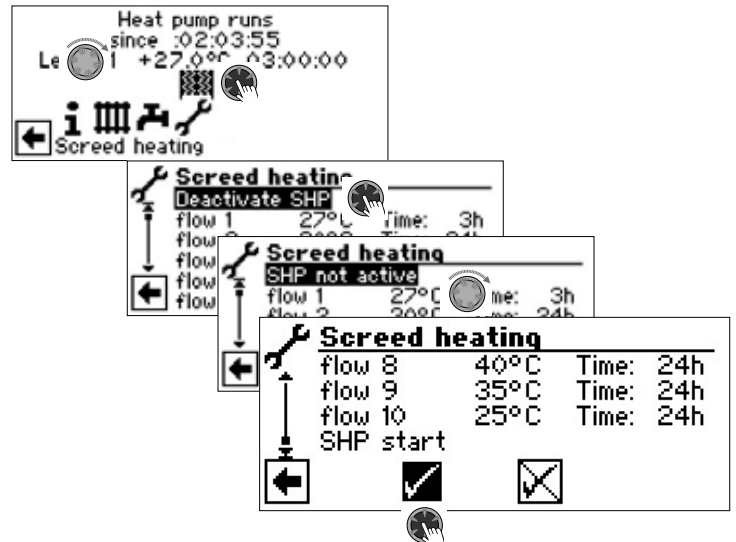



HEATPUMP CONFIGURATION

NOTE

If there is a type of use which is not required for your system, it is not necessary for the associated program areas to be represented in the screen.

An example: Your system is only designed for heating mode. No components are installed for the domestic hot water preparation. That means you do not require access to the menus of the program area "Domestic hot water". It is therefore not necessary for these menus to be shown in the screen. In the menu "Heatpump configuration" you can specify that these menus do not appear in the screen and therefore remain hidden.

NOTE

However, hiding a menu does not affect the function or operation of a type of use. If the type of use is switched off, this must be set in the menu "Mode of operation".

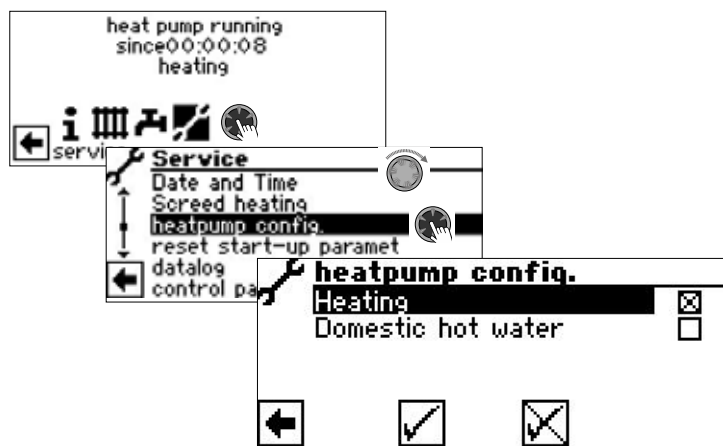

Deselect program area not required.
The example shown reveals that the menus of the program area "Heating" are displayed in the screen. The menus of the program area "Domestic hot water" are not displayed.

STARTUP GUIDE

→ page 12, "Startup guide"

RESET STARTUP PARAMETERS

→ page 13, "Reset startup parameters"

DATA LOGGER

→ Part 1 of the controller manual, program area "Service", section "Data logger".

CONTROL PANEL

Adjusting the contrast of the control unit display

→ Part 1 of the controller manual, program area "Service", section "Basic Information on the operation".

Web server

→ Part 1 of the controller manual, program area "Service", section "Control Panel / Web server".

Remote maintenance

The "Remote maintenance" function enables data exchange between the heating and heat pump control and the remote maintenance server Heatpump24.com. Remote monitoring and remote access to the heating and heat pump control is possible via Heatpump24.com..

The following prerequisites must be fulfilled:

- The heating and heat pump regulator has access to the internet via a broadband connection (DSL) and via a router with open TCP port 443 (HTTPS).
- A valid DNS server is set.
- The current time (date and time) is set in the heating and heat pump regulator.
- The commissioning of the heat pumps will be handled by the manufacturer's customer service representatives.
- The manufacturer makes available a completed application form for remote maintenance.
- A contract with the manufacturer has been negotiated.

NOTE

Remote maintenance is an additional service feature made available by the manufacturer at an additional cost.

NOTE

All settings that are related to the "Remote maintenance" function, may only be handled by authorised service personnel.



Switch on the remote maintenance function

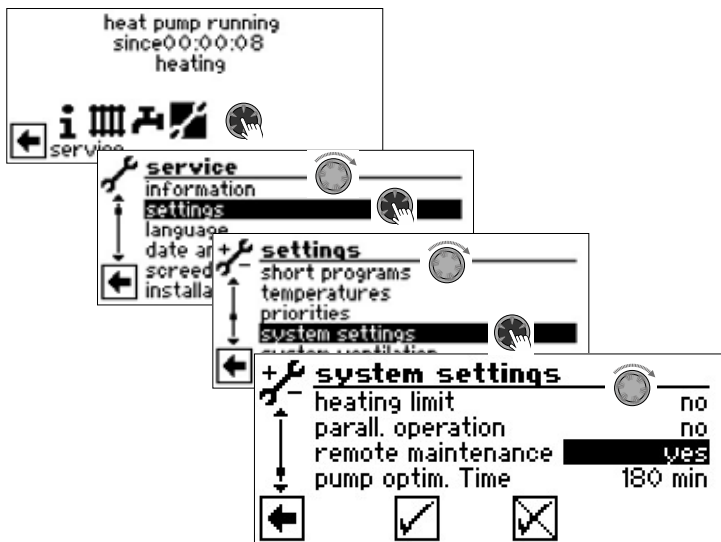

Adjust the remote maintenance function

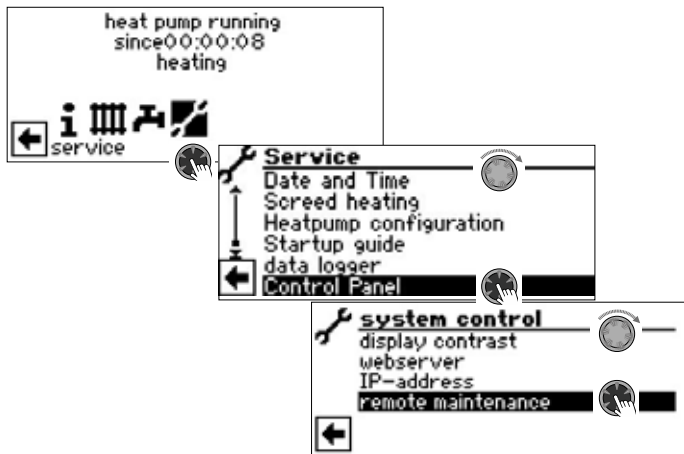

Check connection

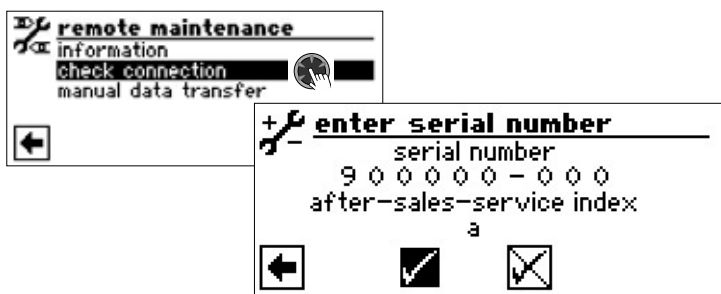

Enter the serial number of the heat pump



NOTE

A connection with the remote maintenance server is only possible if the serial number of your heat pump is correctly entered. The heat pump serial number can be found on the rating plate attached to the housing of the heat pump.

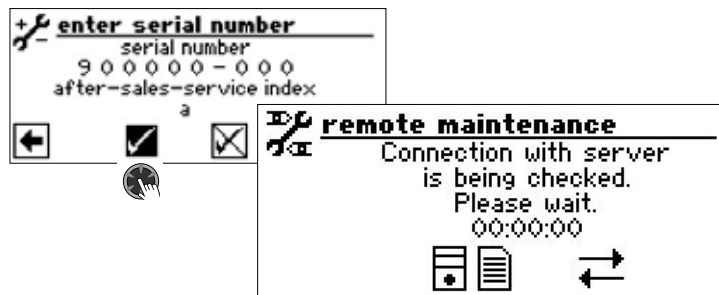

If errors occur during the checking of the connection, a corresponding warning will appear on the screen of heating and heat pump regulator:



→ page 37, "Error causes with connection problems"

Manual data transfer

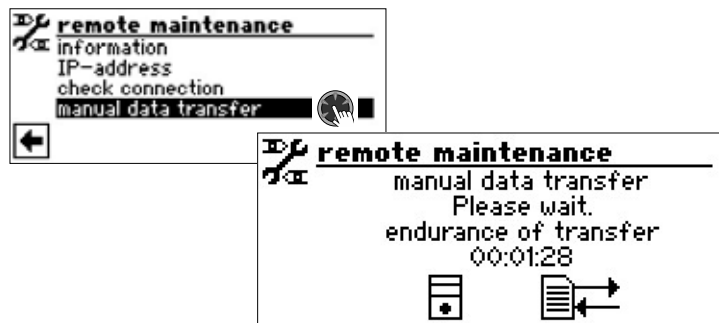

If connection problems arise, the following message will appear on the screen:



→ page 37, "Error causes with connection problems"



Error causes with connection problems

If a connection with the remote maintenance server is not possible, the causes may include:

- The heating and heat pump regulator has no connection to the internet.
- The standard gateway in the “System control / IP address” is not correctly set up.
- TCP port 443 (HTTPS) is not activated for the heating and heat pump regulator.
- The set DNS server is not accessible.
- Date and time set in the heating and heat pump regulator are not up to date.
- The IP address of the heating and heat pump regulator is not adjusted to conform to your local network.

If connection problems arise, check all settings associated with “Remote maintenance”, “Web server”, and “System control / IP address”. Correct the settings as needed.

If, thereafter, a connection with the remote maintenance server is still not possible, contact the customer service representatives of the manufacturer.

Information on the remote maintenance function

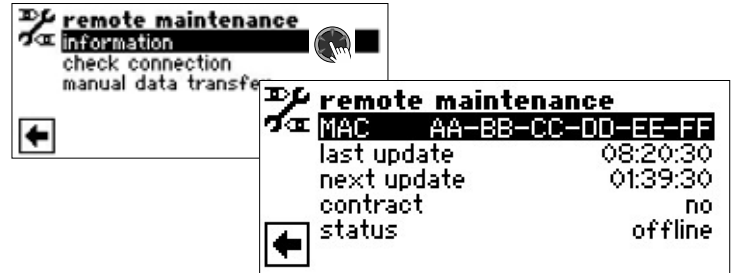

MAC

MAC address of the controller.

Data must be shared with the manufacturer by the time the contract is signed.

last update

elapsed time since the last activation of the remote maintenance

next update

time until the next automatic activation of the remote maintenance

contract

description of the closed remote maintenance contract

status

status of the remote maintenance

Offline standard display (is most often displayed)

Online connection to the remote maintenance server is established and active

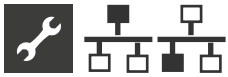

Program area “Parallel connection”

BASIC INFORMATION

NOTE

Parallel operation is not possible with hydraulic module 2.

The parallel connection is used to connect up to four heat pumps to each other via standard network cabling so that they work together in a common heating system.

NOTE

Parallel operation is only possible if all integrated heat pumps have the same number of compressors (**either** 1-compressor-units **or** 2-compressor-units).

The connection to the parallel mode is made via the Ethernet interface on the control unit of the heating and heat pump control. The control unit is either attached directly to the individual heat pump or to the indoor unit of this heat pump.

NOTE

Individual room control with NOVELAN Smart is not possible in parallel mode.

If more than 2 heat pumps or associated indoor units are to be connected to each other, a hub or switch (accessory) is required.

One of the interconnected heat pumps takes over the control of the the heating and cooling of the entire system..The other heat pumps operate as “slaves”.

NOTE

Only one of the interconnected heat pumps may be set as master.

The outdoor sensor and the external return flow sensor (TRLExt) of the heating system must be connected to this master.

The el. sup. blockade must be connected to each individual heat pump. In the event of an el. sup. blockade on the master, heating or cooling is also blocked at the slaves.

Only one slave heat pump of the parallel mode can be used for domestic hot water preparation. To be able to prepare domestic hot water using this slave heat pump, the associated domestic hot water sensor must be connected to this slave heat pump.

While this slave heat pump is preparing domestic hot water, it is excluded from the control compound for heating and cooling and is not controlled by the master heat pump.

NOTE

With parallel mode, the program section “Photovoltaics” can only be used on the master. The prerequisite for this is an installed Comfort board in the heating and heat pump control of the master.

With parallel mode, the program section “Swimming pool heating” can only be used on a slave. The prerequisite for this is an installed Comfort board in the heating and heat pump control of this slave.

If heating or cooling is required, the compressor with the fewest operating hours (compressor running time) is switched on first. Depending on the requirement, further compressors are switched on in the appropriate manner.

If a parallel system consists of heat pumps with 2 compressors each, a second compressor of a heat pump is only switched on when all of the first compressors of all units are running.

The individual compressors are always enabled regardless of the outside temperature and cannot be disabled.

After the end of the heating request, the compressor that was switched on first is switched off first.

BROKEN CONNECTION

If the connection between heat pumps is broken for more than 5 minutes, an error is displayed on the screen of the control unit. Depending on the device either 756 (“Lost connection to master”) or 755 (“Lost connection to slave”).

→ page 44, “Error Diagnosis / Error messages”

CONNECTION

Example 1: Connection of the Ethernet interfaces of the control units via hub or switch (accessory)

4 heat pumps for heating mode, 1 of these heat pumps is also responsible for domestic hot water preparation

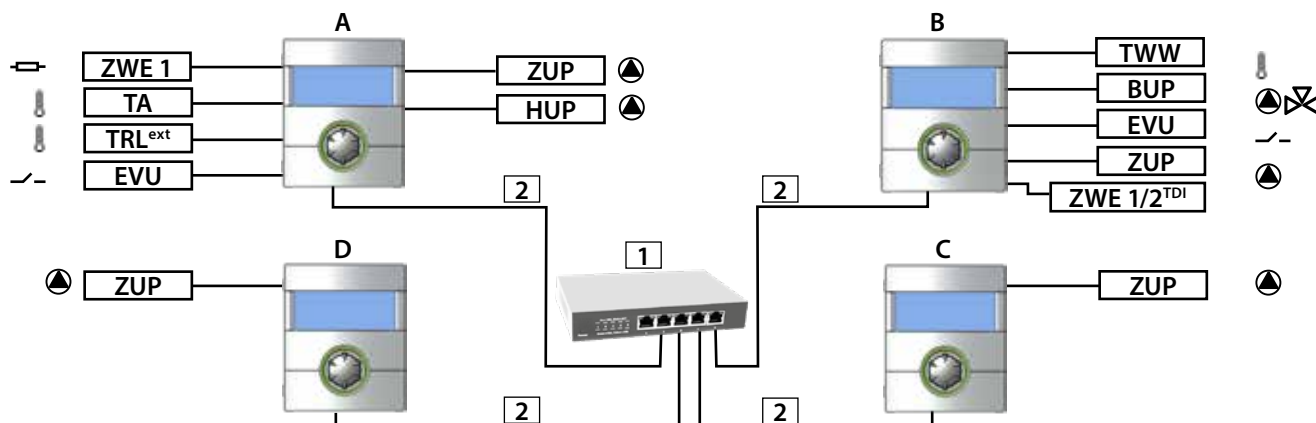

Example 2: Connection via the Ethernet interfaces of the control units

2 heat pumps for heating mode only

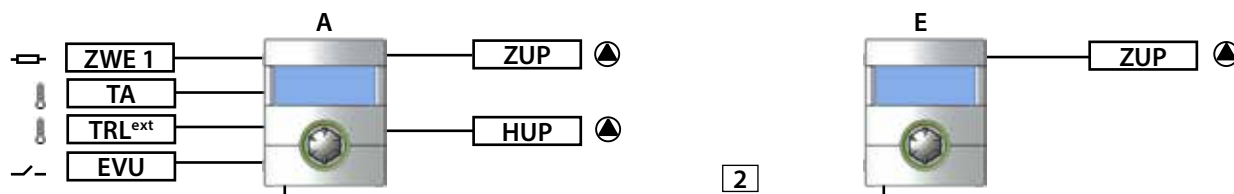

Example 3: Connection via the Ethernet interfaces of the control units

2 heat pumps for heating mode, 1 of these heat pumps is also responsible for domestic hot water preparation

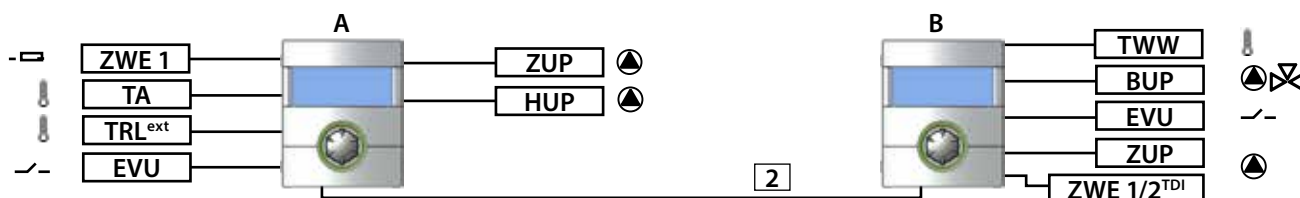

- | | | |
|------------------------|---|----------------------------------|
| TWW | Domestic hot water temperature sensor | |
| ZWE 1 | Second heat generator 1 | |
| TA | External senso | |
| TRL ^{ext} | External return flow sensor | |
| EVU | Release signal electric suppl. | |
| BUP | Domestic hot water pump | |
| ZUP | Additional circulation pump | |
| HUP | Heating circulation pump | |
| ZWE 1/2 ^{TDI} | Second heat generator 1 oder 2 (only possible for "Thermal disinfection") | |
| 1 | Hub or switch with at least 4 ports | RJ-45, 10 Base-T / 100 Base-Tx |
| 2 | Patch cable | RJ-45 (up to 20m) |
| A | Heat pump Master | (in this case heating only) |
| B | Heat pump Slave 1 | (heating and domestic hot water) |
| C | Heat pump Slave 2 | (in this case only heating) |
| D | Heat pump Slave 3 | (in this case only heating) |
| E | Heat pump Slave 1 | (only heating) |

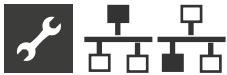

ADDITIONAL HEAT GENERATOR

Heating mode

In heating mode, only ZWE1 of the master heat pump can be switched on. The corresponding settings must be made on the master heat pump.

ZWE1 type: El.Rod

ZWE1 function: HW a DHW

ZWE1 is switched on after twice the switch cycle after the last compressor has been switched on.

The outdoor temperature release ZWE is blocked on the master heat pump.

Preparing domestic hot water

For domestic hot water preparation, ZWE2 of the respective slave heat pump can be switched on. The corresponding settings must be made on the respective slave heat pump.

ZWE1 type: El.Rod

ZWE1 function: HW a DHW

ZWE2 type: El.Rod

ZWE2 function: DHW

MIXING CIRCUITS

Each heat pump in the parallel compound can independently control mixing circuits. The settings for these mixing circuits must be made on the respective heat pump.

HEAT QUANTITY AND ENERGY INPUT

The heat quantity recording and the calculation of the energy consumed are carried out separately for each individual heat pump operating in parallel compound.

Heat quantity and energy used must be queried at each individual heat pump operating in parallel compound.

→ page 20, "Query heat quantity" and page 20, "Query energy input"

SELECT PROGRAM AREA

The program area "Parallel mode" must be set by authorised service personnel during commissioning.

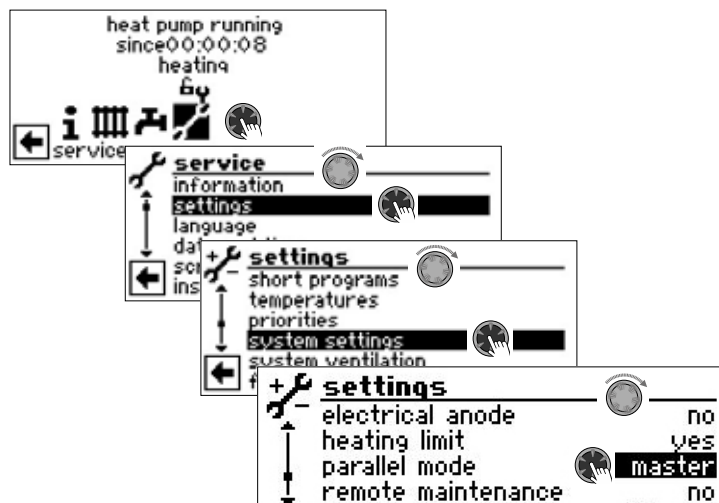

Parallel mode

Only one of the interconnected heat pumps may be set as "Master".

For all other heat pumps, "Slave" must be set here.

Save the settings.



Is the heatpump defined as "Master" you can see this symbol in the navigation screen :



Is the heatpump defined as "Slave" you can see this symbol in the navigation screen :

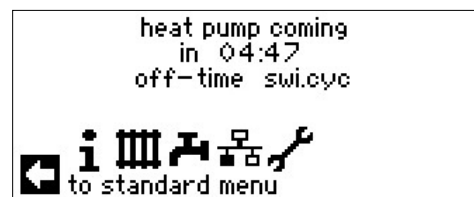

IP-ADRESS

If the heat pumps are connected via a router, the DHCP option "off" must be set on each heat pump..

→ Part 1 of the controller manual, program area "Service", section „Control Panel / Web server“

The network addresses of the heat pumps must be entered manually. The IP addresses of the heat pumps must be different, but the data on subnet mask, broadcast, gateway, DNS1 and DNS2 must match.

Set the network addresses

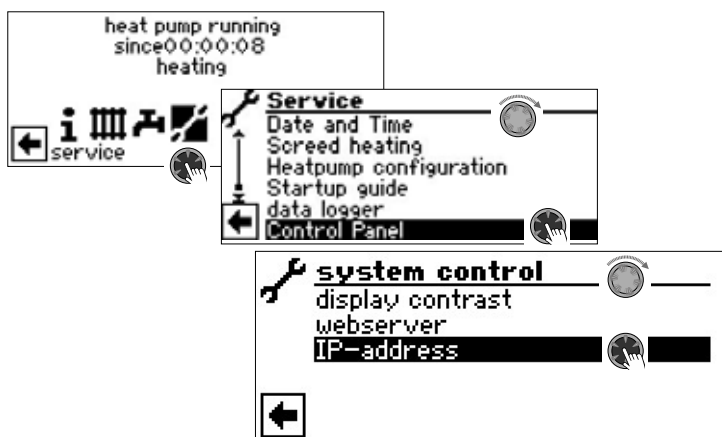

Example

Network setting for the master:

→ IP-address	
← IP	192.168.002.010
subnetmask	255.255.255.000
broadcast	192.168.002.255
gateway	192.168.002.001
DNS 1	192.168.002.001
← DNS 2	192.168.001.001

IP	IP-Adress of the master
Subntzmsk.	IP-Adress must be the same for all heat pumps
Broadcast	IP-Adress must be the same for all heat pumps
Gateway	IP-Adress must be the same for all heat pumps
DNS 1	IP-Adress must be the same for all heat pumps
DNS 2	IP-Adress must be the same for all heat pumps

Scroll all the way down,
save the settings.



Network setting for the slave 1:

→ IP-address	
← IP	192.168.002.011
subnetmask	255.255.255.000
broadcast	192.168.002.255
gateway	192.168.002.001
DNS 1	192.168.002.001
← DNS 2	192.168.001.001

IP address of the slave 1. The first three number blocks (here: 192.168.002) must correspond to the first three number blocks of the master. The fourth number block (here: 011) must differ from heat pump to heat pump. In a system with 2 or 3 heat pump slaves, the last three digits must also be set as unique numbers (different from one another)



NOTE

The first three number blocks of the IP addresses must always be identical (as in the illustrated example: 192.168.002). The fourth number block must always differ from heat pump to heat pump (in the illustrated example: 010 for the master, 011 for the slave 1).

Scroll all the way down,
save the settings.



EXTERNAL RETURN FLOW SENSOR

One parallel connection usually has one single buffer tank for all heat pumps. In this case, the external return flow sensor must be installed in this buffer tank and connected to the master heat pump.

→ page 9, "Assembly and Installation of sensors"



SETTING ON THE MASTER HEAT PUMP

NETWORK

Search for Slaves

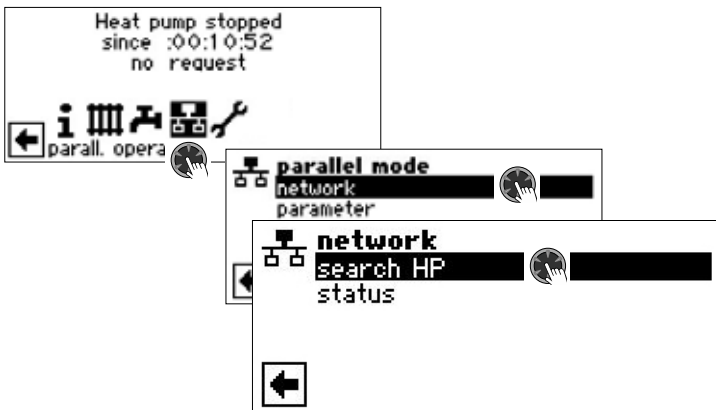

search HP

Selecting "search HP" will initiate a search throughout the network.

NOTE

A successful search requires that all heat pumps that are supposed to work in parallel be switched on and that the network data of all heat pumps are set correctly.

As soon as the search is finished the IP addresses of all heat pumps present in the network and permitted for parallel mode are displayed.

Example

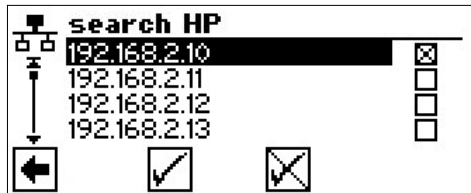

192.168.2.10	IP address heat pump = master
192.168.2.11	IP address heat pump 2
192.168.2.12	IP address heat pump 3
192.168.2.13	IP address heat pump 4

Select a maximum of 3 heat pumps (= IP addresses) that are to work as slaves in parallel mode.

Save the settings.



Status of the master

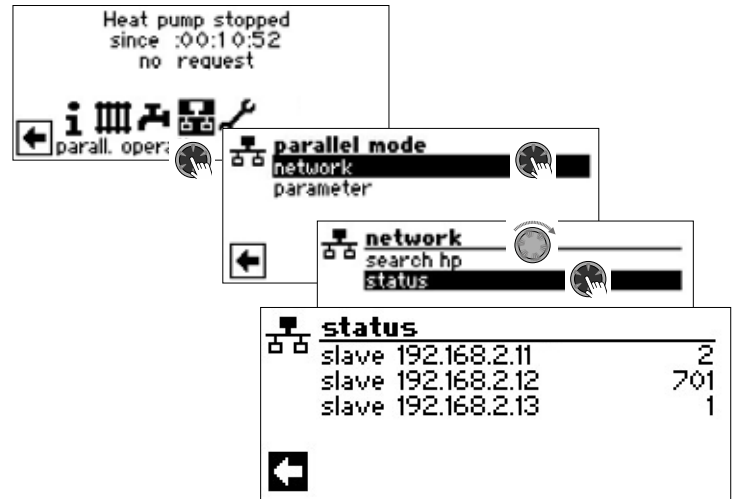

status

This menu shows which information the master receives from the individual slave heat pumps

Possible values

- 0 no compressors activ
- 1 one compressors activ
- 2 two compressors aktiv
- 7xx error: operation of the slave

→ page 44, "Error Diagnosis / Error messages"

SETTING THE HEATING

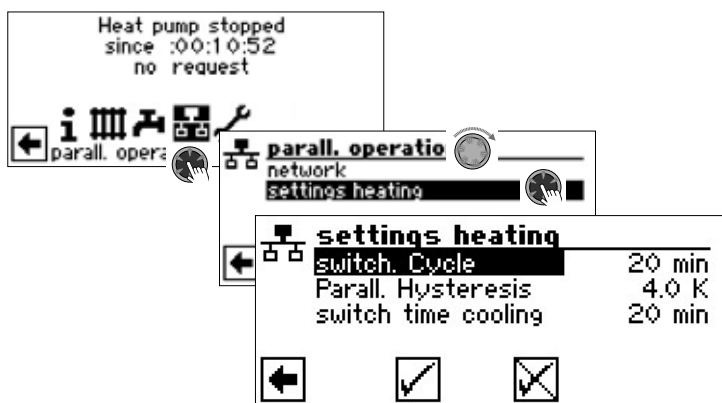

switch Cycle

means heating control time. This time defines at what interval the heating is supposed to switch to the next higher / lower bivalent level (compressor switch-on/shut-off).

This value should not be set to less than 10 minutes for 2 heat pumps. If you set 20 min., it would take 20 minutes until the second compressor stage would be energised following the first compressor stage if a corresponding request is received. The request is determined by the setpoint and actual return temperature of the master. To see how much of the HC time has expired, refer to Information > Elapsed times.

Parall. Hysteresis

In addition to the heating regulator hysteresis there is also a parallel hysteresis for parallel connections. This hysteresis must always be greater than the heating regulator hysteresis of the master heat pump. The purpose of this second hysteresis setting is to cut in half the "HC time" that will expire before the next switch-on/switch-off if this hysteresis is exceeded. This allows for a quicker control response if the difference between setpoint and actual temperature is too great

switch time cooling

means cooling controller time. This time defines at what interval the heating is supposed to switch to the next higher / lower bivalent level (compressor switch-on/shut-off). This value should not be set to less than 10 minutes for 2 heat pumps. If you set 20 min., it would take 20 minutes until the second compressor stage would be energised following the first compressor stage if a corresponding request is received. The request is determined by the temperatures of the master.

Save the settings.





Error Diagnosis / Error messages

No.	Display	Description	Remedy
701	Error low pressure. Please call AS	Low pressure pressostat or low-pressure sensor in the cooling circle has responded (L/W) or for longer than 20 seconds (S/W).	Check HP for leakage, switching point pressure state, defrosting and T-outd.min.
702	Low pressure stop Reset autom.	Only possible for L/W devices: Low pressure in the cooling circle has responded. After some time, automated HP restart.	Check HP for leakage, switching point pressure state, defrosting and T-outd.min.
703	Antifreeze Please call installer	Only possible for L/W devices: If the heat pump is running and the temperature in flow is < 5 °C, antifreeze is detected.	Check HP power, defrost valve and heating system.
704	Error hot gas Reset in hh:mm	Maximum temperature in the hot gas cooling circle exceeded. Automatic HP restart after hh:mm.	Check coolant quantity, evaporation, overheating flow, return and HS-min.
705	Motor protection VEN Please call installer	Only possible for L/W devices: Motor protection has responded.	Check set value and ventilator / BCP.
706	Motor protection BCP Please call installer	Option only possible for S/W- or W/W devices Motor protection of the brine or well water circulating pump or the compressor has responded.	Check set values, compressor, BOS.
707	Coding of HP Please call installer	Break or short-circuit of the coding bridge in HP after the first switch-on.	Coding resistance in HP, check plug and connection line.
708	Return sensor Please call installer	Break or short-circuit in the return sensor.	Check return sensor, plug and connection line.
709	Flow sensor Please call installer	Break or short-circuit in the flow sensor No fault shutdown for S/W- or W/W devices.	Check flow sensor, plug and connection line.
710	Hot gas sensor Please call installer	Break or short-circuit in the hot gas sensor of the cooling circle.	Check hot gas sensor, plug and connection line.
711	External temp. sensor Please call installer	Break or short-circuit in the external temperature sensor No fault shutdown. Fixed value to -5 °C.	Check external temperature sensor, plug and connection line.
712	Domestic hot water sensor. Please call installer	Break or short-circuit in the domestic hot water sensor No fault shutdown.	Check domestic hot water sensor, plug and connection line.
713	HS-on sensor Please call installer	Break or short-circuit in the heat source sensor (inlet).	Check heat source sensor, plug and connection line.
714	Hot gas SW Reset in hh:mm	Check thermal application limit of the HP. Domestic hot water off for hh:mm. Fault only triggers if the compressor is running.	Check flow of domestic hot water, heat exchanger, domestic hot water temperature and circulation pump.
715	High-pressure switch-off Reset autom.	High pressure in the cooling circle has responded. After some time, automated HP restart.	Check flow of HW, overflows, temperature and condensation.
716	High-pressure fault Please call installer	High pressure pressostat in the cooling circle has responded several times.	Check flow of HW, overflows, temperature and condensation.
717	Flow HS Please call installer	Flow switch for W/W devices has responded during the pre-rinsing time or operation.	Check flow, switching point for DFS, filter, air clearance.
718	Max. outside temp. Reset autom. in hh:mm	Only possible for L/W devices: Outside temperature has exceeded permissible maximum value. Automatic HP restart after hh:mm.	Check outside temperature and set value.
719	Min. outside temp. Reset autom. in hh:mm	Only possible for L/W devices: Outside temperature has fallen below the permissible minimum value. Automatic HP restart after hh:mm.	Check outside temperature and set value.
720	HS temperature Reset autom. in hh:mm	Option only possible for S/W- or W/W devices Temperature at evaporation outlet has fallen below the safety value on the HS side several times. Automatic HP restart after hh:mm.	Check flow, filter, air clearance, temperature.
721	Low-pressure switch-off Reset autom.	Low pressure pressostat or low-pressure sensor in the cooling circle has responded. After some time, automated HP restart (S/W and W/W).	Check switching point of the pressostat, flow on HS side.
722	Tempdiff HW Please call installer	Temperature spread in the heating mode is negative (=erroneous).	Check function and location of the flow and return sensor.
723	Tempdiff SW Please call installer	Temperature spread in the domestic hot water mode is negative (=erroneous).	Check function and location of the flow and return sensor.
724	Tempdiff defrosting Please call installer	Temperature spread in the heating circle is > 15 K during defrosting (=danger of frost).	Check function and location of the flow and return sensor, HCP capacity, overflows and heating circles.



No.	Display	Description	Remedy
725	System error DHW Please call installer	Domestic hot water faulty, desired tank temperature is fallen below substantially.	Check circulating pump DHW, tank filling, shutoff move and 3-way valve. Ventilate hot water and SW.
726	Sensor mixing circ 1 Please call installer	Break or short-circuit in the mixing circle sensor.	Check mixing circle sensor, plug and connection line.
727	Brine pressure Please call installer	Brine pressure pressostat has responded during the pre-rinsing time or during operation.	Check brine pressure and brine pressure pressostat.
728	Sensor HS Off Please call installer	Break or short-circuit in the heat source sensor at the HS outlet.	Check heat source sensor, plug and connection line.
729	Rotating field error Please call installer	Compressor without power after switching on.	Check rotating field and compressor.
730	Screed heating error Please call installer	The screed heating program could not reach an FL temperature level in the specified time interval. Screed heating program continues running.	The screed heating program could not reach an FL temperature level in the specified time interval. Screed heating program continues running.
731	Timeout TDI	The temperature required for thermal disinfection could not be reached within the set switching times.	
732	Cooling fault Please call installer	The hot water temperature of 16 °C has been fallen short of several times.	Check mixer and heating circulation pump.
733	Anode fault Please call installer	Fault input of the impressed current anode has responded.	Check connection line between anode and potentio stat. Fill SW tank.
734	Anode fault Please call installer	Error 733 present for more than two weeks and domestic hot water is locked.	Acknowledge error in order to release domestic hot water preparation again. Rectify 733.
735	Error Ext. En Please call installer	Only possible with installed expansion board: Break or short-circuit in the sensor "External energy source".	Check sensor "External energy source", plug and connection line.
736	Error solar collector Please call installer	Only possible with installed expansion board: Break or short-circuit in the "solar collector" sensor.	Check "solar tank" sensor, plug and connection line.
737	Error solar tank Please call installer	Only possible with installed expansion board: Break or short-circuit in the "solar tank" sensor.	Check "solar tank" sensor, plug and connection line.
738	Error mixing circle 2 Please call installer	Only possible with installed expansion board: Break or short-circuit in the "mixing circle 2" sensor.	Check "mixing circle 2" sensor, plug and connection line.
739	Error mixing circle 3 Please call installer	Only possible with installed expansion board: Break or short-circuit in the "mixing circle 3" sensor.	Check "mixing circle 3" sensor, plug and connection line.
750	Return sensor external Please call installer	Break or short-circuit in the external return sensor.	Check external return sensor, plug and connection line.
751	Phase monitoring fault	Phase-sequence relay has responded.	Check rotary field and phase-sequence relay.
752	Flow error	Phase-sequence relay or flow switch has responded.	see errors No. 751 and No. 717.
755	Lost connection to slave Please call installer	A slave has not responded for more than 5 minutes.	Check network connection, switch, and IP addresses. Perform HP search if necessary.
756	Lost connection to master Please call installer	A master has not responded for more than 5 minutes.	Check network connection, switch, and IP addresses. Perform HP search if necessary.
757	Low-pressure fault in W/W-appliance	Low-pressure pressostat in the W/W-appliance has triggered either repeatedly or for more than 20 seconds.	If this malfunction occurs three times, the installation can only be cleared again by authorised service personnel!
758	Defrosting malfunction	Five times in a row, defrosting has either lasted longer than 10 minutes or was terminated with a feed temperature of < 10 °C.	Check flow rate. Check flow sensor.
759	TDI message	Unable to correctly carry out thermal disinfection 5 times in succession.	Check setting of additional heating generator and safety temperature limiter.
760	Defrosting fault	Defrosting ended 5 times in succession by maximum time (strong wind impinges on evaporator) .	Protect the fan and evaporator from strong wind.
761	LIN timeout	LIN connection interrupted	Check cable/contact.
762	Sensor compressor intake	Tü sensor error (compressor intake).	Check sensor, replace if necessary.
763	Sensor evaporator intake	Tü1 sensor error (evaporator intake).	Check sensor, replace if necessary.
764	Sensor compressor heater	Sensor error compressor heater.	Check sensor, replace if necessary.



No.	Display	Description	Remedy
765	Suction gas Overheating (SSH)	Suction gas overheating longer than 5 minutes above / below 2K. Reset autom. after 5 minutes or manually.	If the error occurs several times, the refrigerant circuit is permanently blocked. Please call AS
766	compressor's functional range	Operation for 5 minutes outside the compressor's functional range. Reset if TRLeXT > 1746°C or after max. 2 h	If there is an ZWE, switch on the ZWE for heating.
767	STB E-Rod	STB of the heating element has been activated.	Check the heating element and press the fuse back in.
768	Flow monitoring	Insufficient flow in defrost cycle.	Check hydraulics, check pump, check flow.
769	Pump control	No valid flow signal from the circulating pump. Reset autom	Check the wiring of the load and control cables of the circulation pump. Check the circulating pump. Remedy fault.
770	Low overheat	Overheating lies below the limit value for a lengthy period.	Check the temperature sensor, pressure sensor and expansion valve.
771	High overheat	Overheating lies below the limit value for a lengthy period.	Check the temperature sensor, pressure sensor, fill quantity and expansion valve.
775	SEC EVI valve	Electronic expansion valve is no longer recognised by the control in the EVI circuit	Check the expansion valve, connection cable and if applicable the SEC board
776	limit of application-CP	Compressor operates outside its use limits for a lengthy period.	Check the thermodynamics.
777	Expansion valve	Electronic expansion valve is defective.	Check the expansion valve, connection cable and if applicable the SEC board.
778	Low pressure sensor	Low-pressure sensor is defective.	Check the sensor, connector and connection cable.
779	High pressure sensor	High-pressure sensor is defective.	Check the sensor, connector and connection cable.
780	EVI sensor	EVI sensor is defective.	Check the sensor, connector and connection cable.
781	Liquid temp. sensor before EXV	Liquid temperature sensor upstream of the ex-valve is defective.	Check the sensor, connector and connection cable.
782	Suction gas EVI temp. sensor	Suction gas EVI temperature sensor is defective.	Check the sensor, connector and connection cable.
783	Communication SEC board – Inverter	Connection between the SEC board and the inverter is disrupted.	Check the connection cable, interference suppression capacitors and wiring.
784	VSS lockdown	Inverter is blocked.	Disconnect the complete system from the power supply for 2 minutes. If it occurs again, check the inverter and compressor.
785	SEC-Board defective	Error found in the SEC board.	Replace the SEC board.
786	Communication SEC board – Inverter	Connection between SEC board and HZ/IO is disrupted by the SEC board.	Check the HZ/IO – SEC board wiring.
787	VD alert	Compressor signals faults.	Acknowledge fault. If an error occurs repeatedly, phone the authorised service personnel (customer service).
788	Major VSS fault	Fault in the inverter.	Check the inverter.
789	LIN/Encoding not found	Control unit unable to find coding. Either the LIN connection is interrupted or the coding resistor is not detected.	Check the connection cable LIN / coding resistor.
790	Major VSS fault	Fault in the power supply of the inverter / compressor.	Check the wiring, inverter and compressor.
791	ModBus connection lost Inverter	The control panel has no ModBus communication with the inverter for at least 10 seconds or 10 communication packets to the inverter were lost. Reset autom	Check the Modbus wiring of inverter.
792	LIN-connection lost	Unable to find a master board or any configuration.	Check the coding connector on the LIN board(s).
793	Inverter Temperature	Temperature sensor fault in the inverter. Internal inverter temperature too high at least 5x within 24 h.	Fault acknowledges itself.
794	Overvoltage	Overvoltage on inverter.	Check the inverter voltage supply.



No.	Display	Description	Remedy
795	Undervoltage	Undervoltage on inverter.	Check the inverter voltage supply.
796	Safety switch off	Safety Input was triggered. Manual reset required. Case 1: Inverter malfunction. Case 2: High-pressure pressostats in refrigerating circuit have triggered Case 3: Only LADV / Helox malfunction message caused by voltage fluctuations exceeding the valid standard.	Case 1: Check inverter. Remedy fault. Case 2: Check HW throughflow, overflow, flow temperature sensor and high-pressure sensor. Remedy fault. Case 3: It must be turned off and resecured manually
797	MLRH is not supported	Heating rod regulating is not supported.	–
798	ModBus connection lost Fan	No ModBus communication with the fan for at least 10 seconds. Reset autom.	Check ModBus – Fan wiring
799	ModBus connection lost ASB	No ModBus communication with the ASB board for at least 10 seconds. Reset autom.	Check ModBus – ASB board wiring
800	Desuperheater-error	Shutdown is triggered when desuperheater temperature $\geq 80^{\circ}\text{C}$. Device is switched off and D0_Pause is written in shutdowns. Device is released again for operation after 2 hours. If the shutdown occurs 5 times within 24 hours, error 800 is written to the fault memory.	Remove energy from desuperheater memory. The machine can be restarted as soon as the temperature falls $< 80^{\circ}\text{C}$.
801	HP offline	The heating and heat pump controll does not have an Internet connection has no internet connection to the remote maintenance server.	Establish internet connection.
802	Temperature electrical switch box	Shutdown will be triggered when temperature in the electrical switch box $\geq 80^{\circ}\text{C}$. If the temperature falls below 70°C , then the heat pump will start up again. Reset autom.	Check fan for correct function. Check connection cable. Check sensor. Check electrical control box openings for blockages.
803	Temperature electrical switch box Blockage	Error 802 tripped 3 times within 24 hours. Manual reset required. If the temperature in the electrical switch box is still $\geq 80^{\circ}\text{C}$, the error will be triggered again immediately.	Check fan for correct function. Check connection cable. Check sensor. Check electrical control box openings for blockages.
804	Sensor temperature electrical switch box	Sensor error electrical switch box temperature.	Check sensor.
805	Sensor desuperheater	Sensor error desuperheater temperature.	Setting in the menu "FlexConfig - Out2" is set to "Enth" although this is not required. Deselect "Enth" Check sensor.
806	ModBus SEC	The SEC-board has no ModBus communication for at least 10 seconds or query has failed 10 times in a row. Reset autom.	Check ModBus – SEC board wiring.
807	Lost ModBus communication	All possible ModBus communication faults with unit components for the respective unit are present simultaneously for at least 10 seconds. Reset autom.	Check ModBus interface on the control unit, connection cable to ModBus distributor and ModBus distributor itself. Check Modbus wiring.
808	Hardware not supported	Software version of the heating and heat pump controller is incompatible with installed ASB hardware.	Carry out software update
809	Overheating hot gas (DSH)	DSH_break was triggered 3 times within 24 h. Reset autom. after 5 minutes or manually.	If the error occurs several times, please call AS
810	version parallel mode	The heating and heat pump controls connected in parallel operation have different software versions.	Update the software versions of the heat pumps connected for parallel mode to an identical version. Reset manually.
811	Check condensate pan Please call installer	COPS float switch has tripped.	Remove water from condensate overflow protection tray. Clean the condensate pan in the heat pump including the drain. Reset manually.
812	Maximum flow rate	Maximum permissible flow rate of the circulation pump was exceeded 5 times within 24 h	Please call installer



No.	Display	Description	Remedy
813	Inverter not compatible Please call installer	The inverter of the heat pump is not compatible. The compressor of the heat pump is blocked. Only operation with ZWE is possible.	Replace the inverter. Reset manually.

ACKNOWLEDGING A FAULT

If a fault occurs and an error message appears in the screen, then:

1. Notice error number.
2. Acknowledge error message by pressing the “rotary pushbutton” (for 7 seconds).
The screen changes from the error message to the navigation screen.
3. If this error message occurs again, contact the fitter or authorised service personnel (= customer service), if the error message prompted you to do this. Communicate error number and arrange further procedure.

FLASHING CODES ON CONTROLLER BOARD

Only LAD..., SIP 37.1 to SIP 69.1, SIP 29.1H to SIP 56.1H:

Green LED flashes every second	everything ok
Red LED flashes briefly for short	Data being received over LIN bus
Green and red LED light up	The board can receive a software update

During the software update the green LED is lit and the red one flickers quickly

Technical Data

INSTALLATION

Only in frost-free, dry and weatherproof rooms.

Ambient temperature: 0 °C – 35 °C

Electrical connection: 230 V AC, 18 VA, 0.1 A
(max. power consumption regulator without any appliances connected)

OUTPUTS

Relay contacts: 8 A / 230 V,

Fuse: 6.3 A (for all relay outputs)

In total consumers up to 1,450 VA can be connected to the outputs

INPUTS

Optocoupler: 230 V

Sensor inputs: NTC sensor 2.2 kΩ / 25 °C

CONNECTIONS

Control line: 12-pole, outputs 230 V

Sensor line: 12-pole, low voltage

Plug-in terminals: 1-pole, screw terminals

INTERFACES

USB: USB version 2.0 (USB 2.0)

Host, A plug (only for a USB stick!)

Ethernet: 1 x 10 Base-T / 100 Base-TX
(RJ-45, plug, bent)

PROTECTION CLASS

Protection class IP 20

TEMPERATURE SENSOR CHARACTERISTIC CURVE

t / °C	R / kΩ
-25	21.291
-20	16.425
-15	12.773
-10	10.010
-5	7.903
+/-0	6.284
+5	5.030
+10	4.053
+15	3.287
+20	2.681
+25	2.200
+30	1.815
+35	1.505
+40	1.255
+45	1.051
+50	0.885
+55	0.748
+60	0.636
+65	0.542
+70	0.464
+75	0.399
+80	0.345
+85	0.299
+90	0.260
+95	0.227
+100	0.198
+105	0.174
+110	0.153
+115	0.136
+120	0.120
+125	0.106
+130	0.095
+135	0.085
+140	0.076



SENSOR MEASURING RANGE

Type of sensor	Measuring range	Autom. value in case of sensor defect
PEX	-40°C to 40°C	-
TA	-50°C to 90°C	-5 °C
TBW	-45°C to 155°C	75 °C
TFB1	-20°C to 150°C	75 °C
TRL ext	-40°C to 40°C	5 °C
TVL	0°C to 100°C	5 °C
TVL2/TEH	0°C to 100°C	5 °C
TRL	0°C to 100°C	5 °C
Comfort board 2.0		
TSS	-20°C to 140°C	150°C
TSK	-20°C to 140°C	150°C or 5°C
TB2	0°C to 100°C	75°C
TB3	0°C to 100°C	75°C
TEE	0°C to 100°C	5°C

Overview: Defrost cycle, Air defrost, Flow Max

	Defrost cycle	Air defrost		Flow Max	
		from / end	flow Max.	min. AT flow max.	low limit of applic.
LIC 6M	45	–	57		
LIC 8M	45	–	57		
LIC 6	60	7/6	61	-7	52
LIC 8	60	7/6	61	-7	52
LIC 10	60	7/6	57		
LIC 12	60	7/6	57		
LA 7	60	–	57		
LA 8	60	–	57		
LI (LA) 10	60	–	57		
LI (LA) 12	60	7/6	57		
LI (LA) 15	60	–	59		
LI (LA) 19	45	–	59		
LI(L) (LA) 25	45	–	61	-4	50
LI(L) (LA) 26	45	–	57		
LI(L) (LA) 33	60	7/6	59		
LI(L) (LA) 10H	45	–	64	-15	60
LI(L) (LA) 18H	45	–	64	-15	60
LI(L) (LA) 15H	45	–	64		
LI(L) (LA) 32H	60	–	64		
LA 9RX	60	7/–	61	-7	50
LA 14RX	60	7/–	61	-7	50
LI (A) 9 Solar	45	9/8	61	-7	50
LA 7.1	60	–	57		
LA 8.1	60	–	57		
LI (LA) 10.1	60	7/6	61	-7	50
LI (LA) 12.1	60	7/6	61	-7	50
LI (LA) 14	60	7/6	61	-7	50
LI (LA) 18	60	7/6	61	-7	50
LI (LA) 25.1	60	7/6	61	-7	50
LI (LA) 30	60	–	60		
LI (LA) 31	60	–	59		
LAD 5	variable	6	70	-7	62
LAD 7	variable	6	70	-7	62
LAD 9	variable	6	70	-2	60
LAD 5/RX	variable	6	70	-7	62
LAD 7/RX	variable	6	70	-7	62



System setting during commissioning

NOTE

The software automatically detects the connected heat pump type. Parameters that are not relevant for the system situation or for the heat pump type are hidden from view. For this reason, some of the parameters contained in this overview may not appear in the display of your heating and heat pump controller.

Parameter	Factory setting	Adjustment during commissioning *)	Value range (adjustable steps)	Access
Program section "Cooling"				
Outd. TP release	20 °C	°C	15 °C – 35 °C (‡1)	User
set temperature MC1	20 °C	°C	18 °C – 25 °C (‡1) integration with "Sep.tank": 5 °C – 25 °C (‡1)	User
hysteresis cool.contr	L/W: 3.0 K S/W: 2.0 K		1 K – 5.0 K (‡0.5)	Fitter
Target return cooling	20 °C	K	13 °C – 25 °C (‡0.5)	User
max. outs. temp.	12 h	h	0 h – 12 h (‡0.5)	User
min. outs. temp.	12 h	h	0 h – 12 h (‡0.5)	User
max. room. temp.	12 h	h	0 h – 12 h (‡0.5)	User
Temperatures				
Limit Return	50 °C	°C	35 °C – 70 °C (‡1)	Fitter
Hysteresis HC	2.0 K	K	0.5 K – 6.0 K (‡0.5)	Fitter
hysteres.SW	2.0 K	K	1.0 K – 30.0 K (‡1)	Fitter
RT incr.max	7.0 K	K	1.0 K – 10.0 K (‡1)	AS
Release 2 CP	5 °C	°C	-20 °C – 30 °C (‡1)	Fitter
Release ZWE	L/W: -2 °C S/W & W/W: -16 °C	°C	-20 °C – 20 °C (‡1)	Fitter
Tp-defr.Air.	7 °C	°C	6 °C – 20 °C (‡1)	AS
TVth.disinf2	65 °C	°C	50 °C – 70 °C (‡1)	User
Flow 2. CP SW	50 °C	°C	10 °C – 70 °C (‡1)	Fitter
T-outd. max	35 °C LAD-R: 40 °C	°C	20 °C – 45 °C (‡1)	AS
T-outd. min	-20 °C	°C	-20 °C – 10 °C (‡1)	Fitter
T-HS min	Brine: -9 °C Wat./Brine: 1 °C Wat./Wat.: 3 °C	°C	-20 °C – 20 °C (‡1)	AS
T-HG max	130 °C	°C	100 °C – 150 °C (‡1)	Factory
T-def.airend	2 °C LAD-R: 6 °C	°C	2 °C – 10 °C (‡1)	AS
lowering to	-20 °C	°C	-20 °C – 10 °C (‡1)	User
flow Max.	L/W: device-dependent LAD, LAD-R: 70 °C S/W & W/W: 64 °C	°C	35 °C – 75 °C (‡1)	AS
Flow max. MC1	40 °C	°C	25 °C – 75 °C	User
min. AT flow max.	-7 °C L/W: device-dependent	°C	-20 °C – 5 °C (‡1)	Fitter
low limit of applic.	L/W: device-dependent LAD, LAD-R: 62 °C S/W & W/W: 52 °C	°C	35 °C – 75 °C (‡1)	AS
hysteresis cool.contr	L/W: 3.0 K S/W: 2.0 K		1 K – 5.0 K (‡0.5)	Fitter

*) Please enter the adjusted values. Mark not applicable with — .



Parameter	Factory setting	Adjustment during commissioning *)	Value range (adjustable steps)	Access
service water max	65°C	°C	30 °C – 65 °C (‡0.5)	🔧 Fitter
min.systemtemp.	15°C	°C	15 °C – 30°C (‡0.5)	👤 User
Defrost end temperature	45 °C		35 °C – 45 °C (‡1)	🔧 AS
minimal flow mc 1	20°C	°C	20 °C – 40 °C (‡1)	🔧 Fitter
maximum flow mc 1	45°C	°C	25 °C – 75 °C (‡1)	🔧 Fitter
Hysteresis 2.CP short	4.0 K	K	2 – 6 (‡1)	🔧 Fitter
min. flow cooling	18°C	°C	18°C – 25 °C (‡1)	🔧 Fitter
min. flow cooling 2CP	10 °C	°C	7 °C – 20 °C (‡1)	🔧 Fitter
night lowering HC	0 °C	°C	-15 °C – 10°C (‡0,5)	👤 User
night lowering MC1	0 °C	°C	-15 °C – 10°C (‡0,5)	👤 User
System settings				
El. sup. blockade	no ZWE		no ZWE • with ZWE	🔧 Fitter
Roomstat.	No		No • RFV • RBE • Smart	👤 User
Integration	Return		Return • Sep. tank	🔧 Fitter
Mixing circ 1	No		no • charge • discharge • cool • heat+cool	🔧 Fitter
ZWE1 type	El.rod		No • El.rod • Boiler • Thermal	🔧 Fitter
ZWE1 function	HW a SW		No • Heating • HW a SW	🔧 Fitter
ZWE1 capacity	device-dependent 6 kW		0.5 – 27 kW (‡0.1)	🔧 Fitter
ZWE2 type	No		No • El.rod	🔧 Fitter
ZWE2 function	No		No • Heating • SW.	🔧 Fitter
ZWE2 capacity	device-dependent		0.5 – 27 kW (‡0.1)	🔧 Fitter
Error	no ZWE		no ZWE • Heating • DHW • with ZWE	🔧 Fitter
Service water 1	sensor		sensor • Thermal	👤 User
Service water 2	CP		CP • h.wCP	🔧 Fitter
Service water 3	with CP		wo. CP • with CP	🔧 Fitter
Service water 4	set value		set value • Max	🏭 Factory
Service water 5	device-dependent		wo HUP • with HUP • par HUP	🔧 Fitter
SW+HP max	0 h		0 h – 8 h (‡0.5)	👤 User
Defr cycle max	45 min		45 • 60 • 75 • 90 • 120 • 180 • 240 min	🔧 Fitter
Defrost. Air	No		No • Yes	🔧 AS
Defr.Air max	15 min		5 min – 30 min (‡1)	🔧 AS
pump opt.	Yes		No • Yes	👤 User
Access	AS		Fitter • AS	🔧 AS
brine pres/Flow	device-dependent		No • flow • Brine pres • pow.suppl. • pow.+flow	🔧 AS
Control CP	On		Off • On	🔧 AS
setting hc	Set AT		Set AT • Fixed Tp	🔧 Fitter
setting mc1	Set AT		Set AT • Fixed Tp	🔧 Fitter
screed heating	w. mixer		wo. mixer • w. mixer	👤 User
El. Anode	device-dependent		No • Yes	🔧 AS
Heating limit	Yes		No • Yes	👤 User
parall. operation	No		No • Slave • Master	🔧 Fitter
remote maintenance	No		No • Yes	👤 User
pump optim. Time	180 min		5 – 180 min (‡5)	👤 User
time pump flow VBO	1 min		1 – 5 min (‡1)	🔧 Fitter

*) Please enter the adjusted values. Mark not applicable with — .



Parameter	Factory setting	Adjustment during commissioning *)	Value range (adjustable steps)	Access
min defrost cycle	45 min		45 • 60 • 90 • 120 • 180 • 240 • 300	Factory
time 2.CP short	20 min		5 – 20 min (‡1)	Fitter
TDI Message	Yes		No • Yes	Fitter
release ZWE	60 min		20 min - 360 min (‡5)	Fitter
aux. heat. hot water	No		No • Yes	User
aux.serv.water max.	–		1 h – 10 h (‡0.5)	Fitter
smart grid	No		No • Yes	Fitter
setting MC 1	fast		fast • medium • slow	User
type of heat pump	–		SIP 37.1: 37 kW • SIP 45.1: 45 kW SIP 58.1: 58 kW • SIP 69.1: 69 kW SIP 29.1H: 29 kW • SIP 56.1H: 56 kW	User

Pump flow

Pump flow VBO	1 min		1 – 5 min (‡1)	Fitter
Pump flow ZUP	60 s		0 – 60 s (‡5)	Fitter

Smart

Smart Home ID	–		1 – 4 (‡1)	User
Heating circuit	No		No • Yes	User
range +	0 K		0 K – 5 K (‡1)	User
range –	0 K		0 K – 5 K (‡1)	User
mixing circ 1	No		No • Yes	User
range +	0 K		0 K – 5 K (‡1)	User
range –	0 K		0 K – 5 K (‡1)	User
DHW	No		No • Yes	User
intelligent defrost	No		No • Yes	Fitter

Smart Grid

Decrease Heating	-2 K		-0.5 K – -25 K (‡0.5)	Fitter
Increase heating	2 K		0.5 K – 5 K (‡0.5)	Fitter
Increase SW	2 K		0.5 K – 10 K (‡0.5)	Fitter

Settings parallel connection

IP-Addresses				User
Master				User
Slave 1	–		–	User
Slave 2	–		–	User
Slave 3	–		–	User
Switch Cycle	20 min		5 min – 60 min (‡1)	Fitter
Parallel Hysteresis	4.0 K		1 K – 10 K (‡0.5)	Fitter
Switch Time Cooling	20 min		5 min – 60 min (‡1)	Fitter

*) Please enter the adjusted values. Mark not applicable with — .

Abbreviations (selection)

Abbreviation	Meaning
2hg	Second/additional heat generator
Amb. temp.	External/ambient temperature
AS	Customer service
ASD	Defrost, Brine pressure, flow
BCP	Fan, well or brine circulation pump
BLP	Domestic hot water charging pump
BSUP	Well / brine circulating pump
BUP	Domestic hot water circulation pump
BWT	Domestic hot water thermostat
CP	Compressor
Defr/Brin/Flow	Defrost, Brine pressure, flow
DHW	Domestic hot water
EEV	Electronic expansion valve
EEVC	Electronic expansion valve (cooling)
EEVH	Electronic expansion valve (heating)
EP	Expansion board
EVI	Enhanced vapour injection
EVU	Release/off-time signal electrical supply
FUP	Floor heating circulation pump
H(D)V	Performance-controlled hydraulic module (Dual)
HC	Heating circuit
HC Add-time	Heating control more time
HC Less-time	Heating time less time
HD	High-pressure / High-pressure pressostat
HMD	Hydraulic module
HP	Heat pump
HR	Heating circuit regulator
HS	Heat source
HS in	Heat source inlet temperature
HS out	Heat source outlet temperature
HS(D)V	Performance-controlled hydraulic station (Dual)
HT(D)	Hydraulic tower (Dual)
HUP	Heating circulation pump
KR	Cooling circuit regulator
KS	Cooling signal
L/W	Air/Water heat pump
LA	Air/Water heat pump outdoor
LAV	Performance controlled Air/Water heat pump outdoor
LIC	Air/Water Compact heat pump
LICV	Performance controlled Air/Water Compact heat pump
LAD	Air/Water heat pump Dual

Abbreviation	Meaning
LADV	Performance controlled Air/Water heat pump Dual
LAP	Air/Water heat pump serie professional
LI	Air/Water heat pump indoor
LIV	Performance controlled Air/Water heat pump indoor
MA	Mixer open
MC	Mixing circuit
MK	Mixing circuit
MSW	Brine/Water heatpump with IO-Max Board
MZ	Mixer closed
ND	Low-pressure / Low-pressure pressostat
PEX	Party external Room station possible for WS devices potent. ext.
RAD	Radiator
RBE	Room control unit
RFV	Room remote adjuster
S/W	Brine/Water heatpump
SEC	Designation of the circuit board in the switch box of the heat pump
serv.wat.	Domestic hot water
SG	Smart Grid
SLP	Charging pump solar
SUP	Circulation pump swimming pool
SI H	Brine/Water heatpump
SIC	Brine/Water Compact heatpump
SICV	Performance controlled Brine/Water heatpump
SIP	Brine/Water heatpump serie professional
SWT	Swimming poop thermostat
T(F)B (1) (2) (3)	Temperature sensor mixing circuit (1) (2) (3)
TA	Outdoor temperature sensor
TBW	Domestic hot water sensor
TDI	Thermal disinfection
TEE	Temperature sensor external energy source
TFL	Temperature of the liquid refrigerant
TFL 1	Temperature of the liquid refrigerant upstream of the electronic expansion valve (heating)
TFL 2	Temperature of the liquid refrigerant upstream of the electronic expansion valve (cooling)
ThDsin	Thermal disinfection
THG	Temperature sensor hot gas
TRL	Temperature sensor Return
TRL-E	Temperature sensor Return extern



Abbreviation	Meaning
TSG	Temperature sensor suction gas compressor
TSK	Temperature sensor solar collector
TSS	Temperature sensor solar tank
TVD	Temperature sensor compressor heating
TVL	Flow temperature sensor
TWA	Temperature sensor heat source outlet
TWE	Temperature sensor heat source inlet
T-WQ	Temperature heat source
TWW	Temperature sensor domestic hot water
UFH	Floor heating circuit
UWP	Circulation pump
VBO	Fan, well or brine circulation pump
VD	Compressor
W/W	Water/water heat pump
WP	Heat pump
WW	Domestic hot water
WIC	Water/water Compact heat pump
WWT	Domestic hot water thermostat
WS	Bine/Water heatstation
WSV	Performance controlled Bine/Water heatstation
ZIP	Circulation pump
ZUP	Additional circulation pump
ZWE	Second/additional heat generator

NOTE

Abbreviations that appear in the display of the heating and heat pump controller are explained in the respective menus and submenus. Abbreviations can also be found in the operating manual of your appliance in the legends for:

- performance curves
- dimensional drawings
- installation plans
- hydraulic integration
- terminal and circuit diagrams



NOVELAN



NOVELAN

ait-deutschland GmbH

Industriestraße 3 · 95359 Kasendorf

T +49 9228 / 99 607 - 0

F +49 9228 / 99 607 - 1099

info@novelan.com

www.novelan.com

An ait-deutschland GmbH brand

Subject to technical amendments without prior notice.

www.novelan.com